

# **STORMWATER MANAGEMENT**

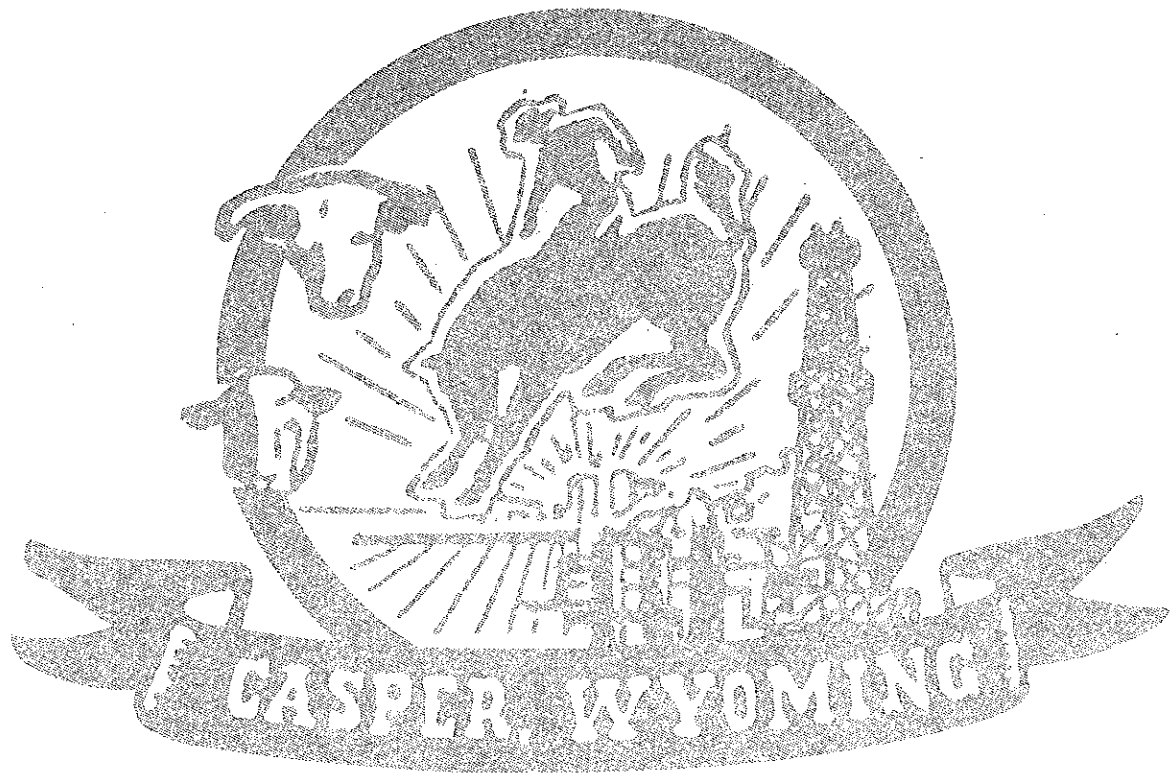

# **DESIGN MANUAL**

## PREFACE

Urbanization may be defined as the process of altering from rural to urban the regional land-use patterns. This transformation has had many impacts on our society. These impacts have technical, economic, social, and political implications which have resulted in a rapid shifting of public attitudes towards the identification of the problems of urbanization, and a growing emphasis in governmental attitudes towards the treatment of these problems.

Among these problems are the management of excess stormwater and the control of soil erosion and sedimentation. Stormwater management is necessary to preserve and promote the general health, welfare, and economic well-being of the region. Stormwater management is a regional feature that affects all governmental jurisdictions and all parcels of property. This characteristic makes it necessary to formulate a program that balances public and private involvement. Although the overall coordination and master planning should be provided by the governing units most directly involved, stormwater management planning and programming should also be regionally integrated to include state and national agency interests.

Concurrent with the management of excess stormwater is the problem of soil erosion and sedimentation in developing areas. As with stormwater management, soil erosion and sedimentation control are regional concerns which require a balanced effort between public and private entities if desired results are to be achieved.

The intent of this Manual is to present current design procedures and techniques for the management of urban stormwater drainage and control of erosion and sedimentation. The procedures and techniques presented herein are consistent with available data and present understanding of the hydrologic cycle, and have been either developed specifically for the Casper area, or taken from commonly used references where applicable.

Space requirements dictated that some less-frequently used charts and tables be omitted. The designer is encouraged to consult the original references for more comprehensive explanations, design charts, and tables. A Bibliography has been provided at the end of each section for this purpose.

It is not the intent of this manual to limit the designer to specific design procedures or techniques. Other more appropriate methodologies may be used where applicable, provided prior approval is obtained from the appropriate agency. Appropriate agency is defined as the engineer or planner of the entity adopting the plan.

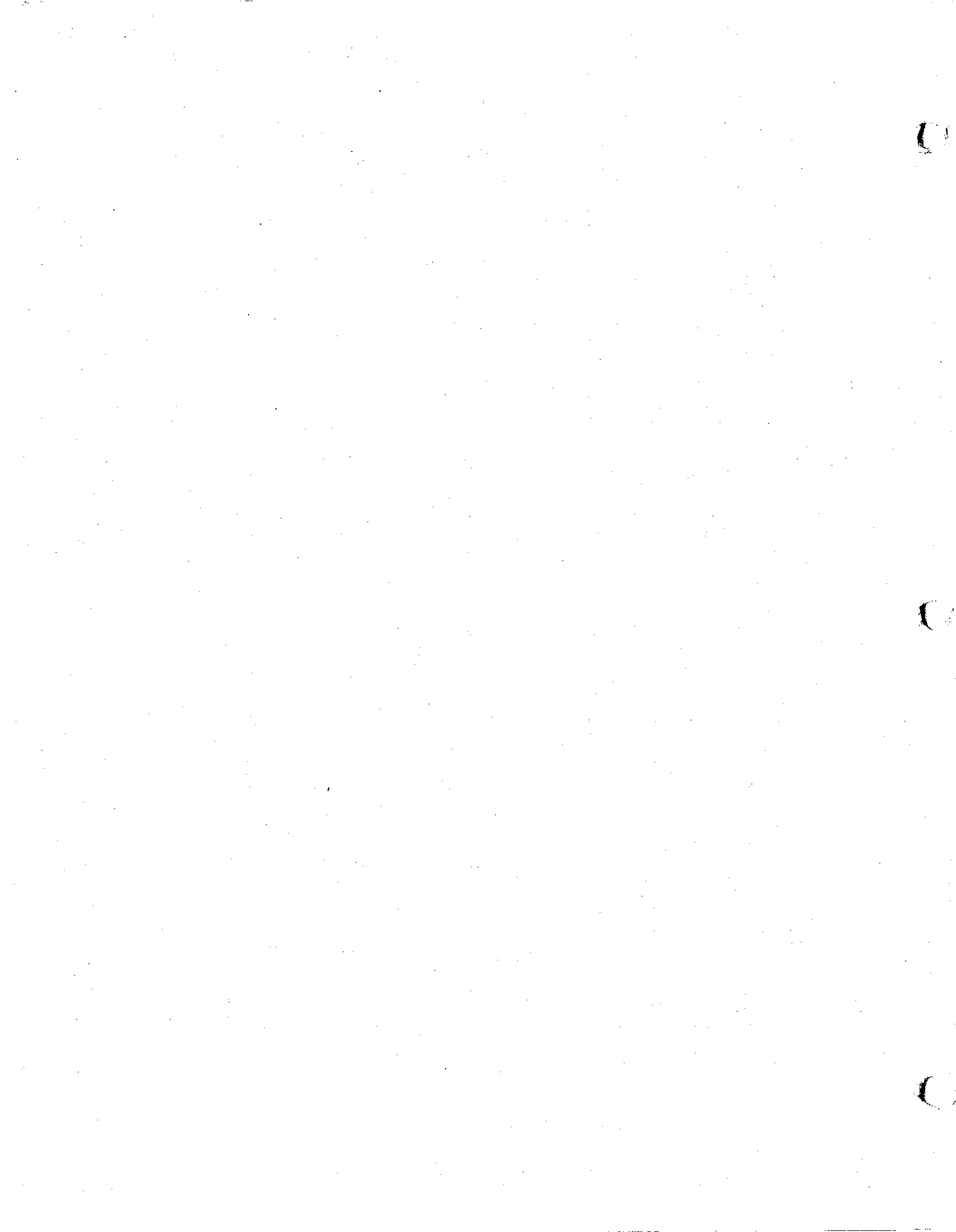

## TABLE OF CONTENTS

### Section 1 Goals and Policies

- 1.10 Goals
- 1.20 Planning and Design Principles
  - Service Subsystem
  - Space Demand
  - Effect on Other Subsystems
  - Assessment Principles
  - Multipurpose Use
- 1.30 Planning Requirements
  - Drainage Master Plan
  - Planning Process
    - Minor Drainage Planning
    - Major Drainage Planning
    - Environmental Design
  - Site Planning
  - Water Quality
  - Lower Drainage Costs
  - Open Space
  - Transportation
  - Channelization
  - Channel Storage
  - Major Runoff Capacity
  - Intrabasin Transfer
  - Interbasin Transfer
  - Basin Planning
  - Upstream Storage
  - Downstream Storage
- 1.40 Design Requirements
  - Design Criteria
  - Criteria Updating
  - Use of Criteria
  - Design Storm Frequencies
  - Initial Storm Provisions
  - Major Storm Provisions
  - Major Drainage Channels
  - Tailwater
  - Storm Runoff
    - Areas under 200 Acres
    - Areas over 200 Acres
    - Accuracy
  - Use of Streets
  - Storage Areas
    - Need for Maintenance
    - Water Quality

## Table of Contents (continued)

- Irrigation Canals
  - Stormwater Conveyance
  - Flood Drainage Liability

1.50 Plat Submittal Standards

1.60 Implementation

### Section 2 Storm Runoff

2.10 Rational Method

- Runoff Coefficient
- Rainfall Intensity
- Time of Concentration
  - Overland Flow
  - Storm Sewer or Road Gutter Flow
  - Channel Flow

2.20 Colorado Urban Hydrograph Procedure

- Limitations
- Definition of Terms
- Basin Characteristics
  - Lag Time
  - Time to Peak
  - Peak Discharge
  - Dimensionless Unit Hydrograph
- Design Storm
  - Rainfall Distribution
  - Losses
  - Rainfall Excess
  - Runoff Hydrograph

2.30 Bibliography

### Section 3 Street Drainage

3.10 Effects of Stormwater on Street Capacity

- Interference Due to Sheet Flow
- Hydroplaning
- Splash
- Interference Due to Gutter Flow
- Interference Due to Ponding
- Interference Due to Water Flowing Across Traffic Lane
- Effect on Pedestrians

## Table of Contents (continued)

- 3.20 Design Criteria
    - Street Capacity for Initial Storms
    - Calculating Theoretical Capacity
    - Street Capacity for Major Storm
    - Calculating Theoretical Capacity
    - Ponding
    - Cross-Street Flow
  - 3.30 Intersection Layout Criteria
    - Gutter Capacity, Initial Storm
    - Gutter Capacity, Major Storm
    - Ponding
    - Cross-Street Flow
  - 3.40 Bibliography
- 
- ### Section 4 Storm Inlets
- 4.10 Inlet Types
  - 4.20 Inlets on a Grade
  - 4.30 Comparison of Inlet Types
  - 4.40 Grate Inlets
    - Capacity of Grate Inlets on a Continuous Grade
    - Capacity of Grate Inlets in a Sag
  - 4.50 Curb-Opening Inlets
    - Capacity of Curb-Opening Inlets on a Continuous Grade
    - Composite Section
    - Explanation of Operation of Inlet
    - Computation by Electronic Calculator
    - Checking for Greater Storms
    - Capacity of Curb-Opening Inlets in a Sag
  - 4.60 Combination Inlets
  - 4.70 Inlet Location
    - Spacing of Inlets on a Continuous Grade
    - Spacing of Inlets in a Sag
  - 4.80 Definition of Symbols for Section 3 and 4
  - 4.90 Bibliography

## Table of Contents (continued)

### Section 5 Storm Drains and Appurtenances

- 5.10 General Criteria
  - Frequency of Design Runoff
  - Velocities and Grades
  - Materials
  - Manhole Location
  - Pipe Connections
  - Utilities
- 5.20 Flow in Storm Drains
  - Pipe Flow Charts
- 5.30 Hydraulic Gradient and Profiles of Storm Sewer
  - Minor Head Losses at Structures
- 5.40 Design Procedure for Storm Sewer Systems
  - Preliminary Design Considerations
  - Inlet System
  - Storm Sewer System
- 5.50 Bibliography

### Section 6 Culvert Design

- 6.10 Design Criteria
  - Design Frequency
  - Culvert Discharge Velocities
- 6.20 Culvert Types
- 6.30 End Treatments
  - Conditions at Entrance
  - Parallel Headwall and Endwall
  - Flared Headwall and Endwall
  - Warped Headwall and Endwall
  - Improved Inlets
- 6.40 Culvert Design with Standard Inlets
  - Culvert Sizing
  - Design Procedure
    - Design Computation Forms
    - Invert Elevations
    - Culvert Diameter
    - Limited Headwater
    - Culvert Outlet
    - Minimum Slope

## Table of Contents (continued)

- 6.50 Culvert Design with Improved Inlets
  - Design Procedure
  - Dimensional Limitations
- 6.60 Design Figures
- 6.70 List of Symbols
- 6.80 Bibliography

### Section 7 Open-Channel Flow

- 7.10 Channel Discharge
  - Manning's Equation
  - Uniform Flow
  - Normal Depth
- 7.20 Design Considerations
- 7.30 Channel Cross Sections
  - Side Slope
  - Depth
  - Bottom Width
  - Trickle Channels
  - Freeboard
- 7.40 Channel Drops
- 7.50 Supercritical Flow
- 7.60 Maintenance of Grassed Waterways
- 7.70 Bibliography

### Section 8 Structures

- 8.10 Energy Dissipators
  - Impact Stilling Basin
  - Plunge Pools
  - Drops
- 8.20 Flow Transitions
- 8.30 Riprap
- 8.40 Bibliography



## Table of Contents (continued)

### Section 9 Storage

#### 9.10 Upstream Storage

- Rooftop Ponding
- Parking Lots
- Recreation Areas
- Property-Line Swales
- Road Embankments
- On-Site Ponds
- Porous Pavements
- Combinations

#### 9.20 Design Criteria

- Design Storms
- Principal Outlets
- Spillways
- Retention of Stormwater
- Site Conditions
- Embankments
- Design Plans

#### 9.30 Hydraulic Design Methods

- Modified Rational Method
- The Colorado Urban Hydrograph Procedure for Storage Analysis

#### 9.40 Bibliography

### Section 10 Flood Proofing

#### 10.10 Flood-Proofing Requirements

#### 10.20 Types of Flood Proofing

#### 10.30 Procedures

- Site Layout
- Elevated Structures
- Waterproofing Structures
- Internal Flood-Proofing Measures

#### 10.40 Engineering Aspects

- Structural Problems
  - Loading from Structure and Contents
  - Restraint from Floor and Roof Systems
  - Resultant of Nonflood and Flood Loading
- Subsurface Drainage
  - Seepage Control
  - Sewage Backup
- Structural Engineering

## Table of Contents (continued)

- 10.50 Flood-Proofing Operations
  - Basement Rooms
  - Utilities
  - Wall Openings
  - Residential Homes
- 10.60 Bibliography
- Section 11 Erosion and Sediment Control
- Section 12 Design Examples
  - 12.10 General
  - 12.20 Street Drainage
    - Allowable Gutter Flow
    - Initial Storm
    - Major Storm
  - 12.30 Inlet Design
    - Inlets on a Continuous Grade
      - Curb-Opening Inlet
      - Grate Inlet
      - Inlet Spacing
    - Inlets in a Sump Condition
      - Initial Storm, Grate Inlet
      - Initial Storm, Curb-Opening Inlet
      - Major Storm
  - 12.40 Storm Sewer Design by the Rational Method
  - 12.50 Detention Basin Design by the Colorado Urban Hydrograph Procedure
  - 12.60 Open-Channel Design
  - 12.70 Trunk Sewer Design by the Colorado Urban Hydrograph Procedure
  - 12.80 Detention Basin Design by the Modified Rational Method
  - 12.90 Culvert Design
    - Standard Culvert
      - Inlet Control
      - Outlet Control
    - Improved-Inlet Culvert Design

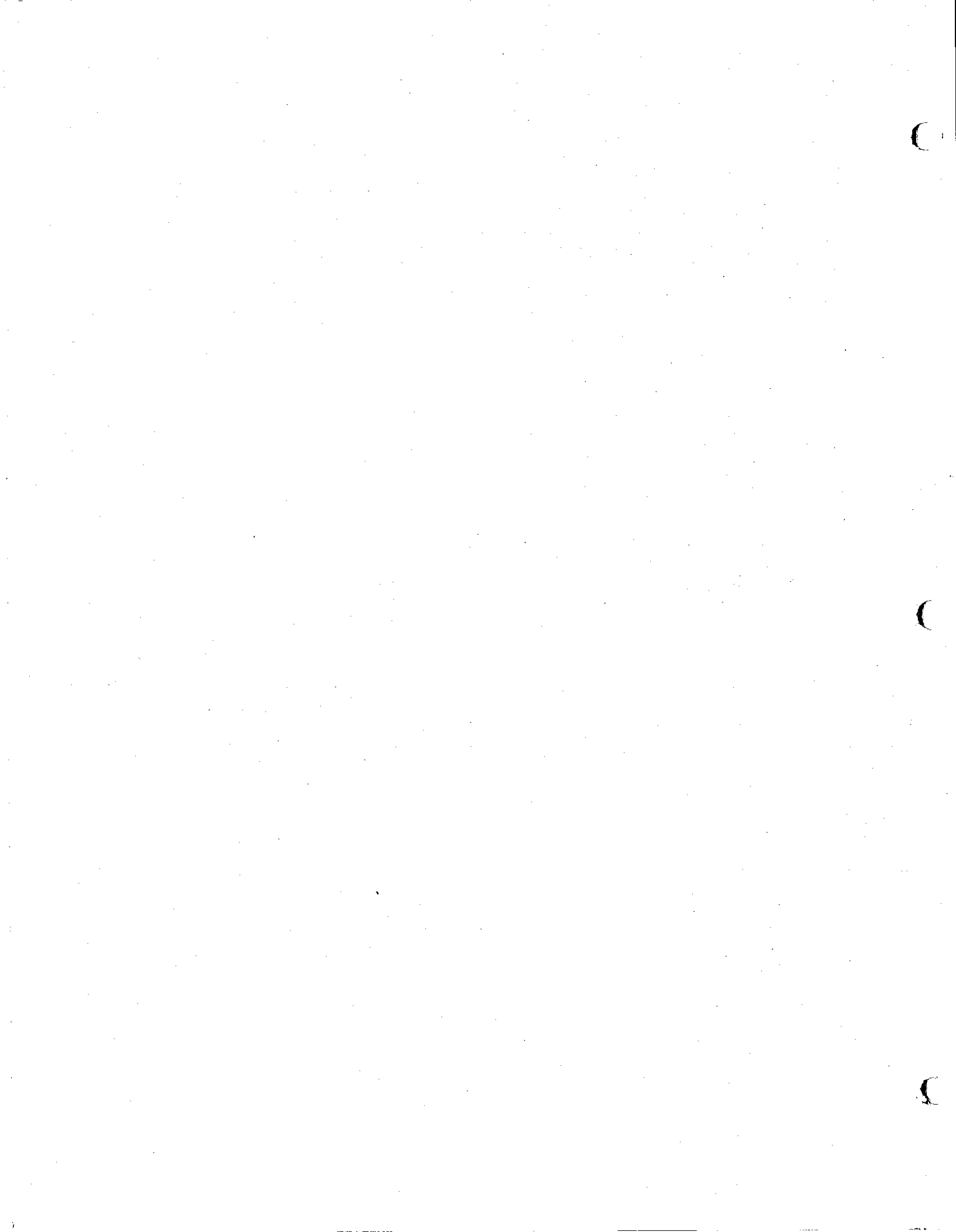

## LIST OF FIGURES

<u>Figure</u>		<u>Page</u>
2-1	Rainfall Intensity-Duration Curves	2-6
2-2	Overland Flow Curves	2-7
2-3	Urban Watershed	2-9
2-4	Relationship of I to $C_t$	2-14
2-5	Relationship of $C_t$ to $C_p$	2-17
2-6	Dimensionless Unit Hydrograph Family Number vs. Dimensionless Unit Hydrograph Shape Factor	2-18
2-7	Runoff Hydrographs and Rainfall Excess Distributions for Example 2	2-28
3-1	Gutter and Pavement Flow Patterns	3-3
3-2	Nomograph for Flow in Triangular Gutters	3-8
3-3	Reduction Factors for Allowable Gutter Capacity	3-11
3-4	Intersection Drainage	3-15
3-5	Reduction Factors for Allowable Gutter Capacity When Approaching an Arterial Street	3-18
4-1	Inlet Types	4-3
4-2	Comparison of Inlets	4-5
4-3	Flow-Characteristics Curves for Grate Inlets	4-29
4-4	Hydraulic Capacity of Grate Inlet in Sump	4-30
4-5	Graphical Definition of Symbols	4-13
4-6	Dimensionless Graph of $Q_i/Q$ vs. $L_i/F_w T$	4-14
4-7	Standard Curb-Opening Inlet Chart	4-31
4-8	Additional Inlet Flow Due to Compound Section	4-32
4-9 to 12	Sump Capacity for Curb-Opening Inlets	4-33 to 36
4-13	Uniform Gutter Flow Curves	4-37

## List of Figures (continued)

<u>Figure</u>		<u>Page</u>
5-1	Uniform Flow for Pipe Culverts	5-17
5-2	Critical Depth of Flow for Circular Culverts	5-18
5-3	Velocity in Pipe Conduits	5-19
5-4a, b	Total Energy Head Losses at Structures	5-21 and 22
6-1 to 5	Culvert Types	6-3, 5, 7, 9 and 10
6-6	Design Computation Form for Culverts	6-16
6-7	Culvert Design Flow Chart	6-19
6-8	Box Culvert Outlet-Control Performance Curves	6-20
6-9	Inlet Modifications to Attain Minimum Required Performance	6-22
6-10	Optimization of Performance in Throat Control	6-24
6-11	Face Design Selections	6-26
6-12	Inlet Structure Dimensions and Design Options	6-28
6-13 to 20	Culvert Capacity	6-46 to 53
6-21 to 24	Outlet-Control Nomograph	6-55 to 58
6-25 and 26	Critical-Depth Chart	6-59 and 60
6-27 to 33	Inlet-Control Nomograph	6-61 to 67
6-34 and 35	Throat-Control Curve	6-68 and 69
6-36 to 38	Face-Control Curve	6-70 to 72
6-39	Headwater Required for Crest Control	6-73
6-40 to 43	Design Computation Form for Improved Culverts	6-74 to 77
7-1	Uniform Flow for Trapezoidal Channels	7-4
7-2	Manning's Formula Nomograph	7-5
7-3	Typical Channel Sections	7-7

List of Figures (continued)

<u>Figure</u>		<u>Page</u>
8-1a, b	Dimensional Criteria for Impact-Type Stilling Basins	8-3 and 4
8-2	Transition Types	8-8
8-3	Minimum Stone Size for Riprap	8-10
9-1	Modified Rational Method Hydrographs	9-8
10-1	Building Loads under Nonflood Conditions	10-6
10-2	Building Loads without Subsurface Drainage	10-7
10-3	Building Loads with Subsurface Drainage	10-8
10-4	Locations for Cutoff Valves on Sewer Lines	10-11
10-5	Elimination of Gravity-Flow Basement Drains	10-11
10-6	Flood-Proofed Building	10-13
11-1	List of Standard Symbols	11-11
11-2	Sample Project Information Sheet	11-12
11-3	Sediment Basin Design Sheet	11-14

## LIST OF TABLES

<u>Table</u>		<u>Page</u>
2-1	Recommended Runoff Coefficients	2-4
2-2	Suggested Runoff Coefficients for Surface Types	2-4
2-3	Frequency Factors for the Rational Formula	2-5
2-4	Values of I for Ultimately Developed Areas	2-13
2-5	Dimensionless Unit Hydrograph Family Number vs. Dimensionless Unit Hydrograph Shape Factor	2-19
2-6	Dimensionless Unit Hydrograph Ordinates	2-20
2-7	Rainfall Increments for the 10- and 100-Year, 2-Hour Design Storms	2-21
2-8	Recommended Depression Storage Volumes for Various Land Covers	2-22
2-9	Determination of Rainfall Excess	2-23, 24
2-10	Determination of Runoff Hydrograph	2-26, 27
3-1	Allowable Initial Storm Runoff Encroachment	3-7
3-2	Allowable Major Storm Runoff Inundation	3-12
3-3	Allowable Cross-Street Flow	3-13
4-1	Computations for Curb-Opening Inlets	4-16
4-2	Computations for Sag Inlets	4-25
4-3	Limiting Conditions of Design Figures	4-27
5-1	Storm Sewer Design Storm Frequency	5-3
5-2	Minimum Slope Required for Scouring Velocity	5-4
5-3	Maximum Velocity in Storm Sewers	5-4
5-4	Roughness Coefficients "n" for Storm Sewers	5-5
5-5	Junction or Structure Loss Coefficient $K_j$	5-10
5-6	Head Loss Coefficients Due to Obstructions	5-11

List of Tables (continued)

<u>Table</u>		<u>Page</u>
5-7	Head Loss Coefficients for Expansions and Contractions	5-12
6-1	Culvert Discharge Velocity Limitations	6-2
6-2	Entrance Loss Coefficients	6-54
7-1	Composite Roughness Coefficients for Channels	7-8
7-2	Roughness Coefficients for Channels	7-9, 10 & 11
7-3	Maximum Permissible Design Velocities	7-11
7-4	Seeding Rates for Grassed Waterways	7-15
8-1	Dimensions for Impact-Type Stilling Basins	8-5
9-1	Development of a $(2S/\Delta t) + 0$ vs. $0$ Relationship	9-13



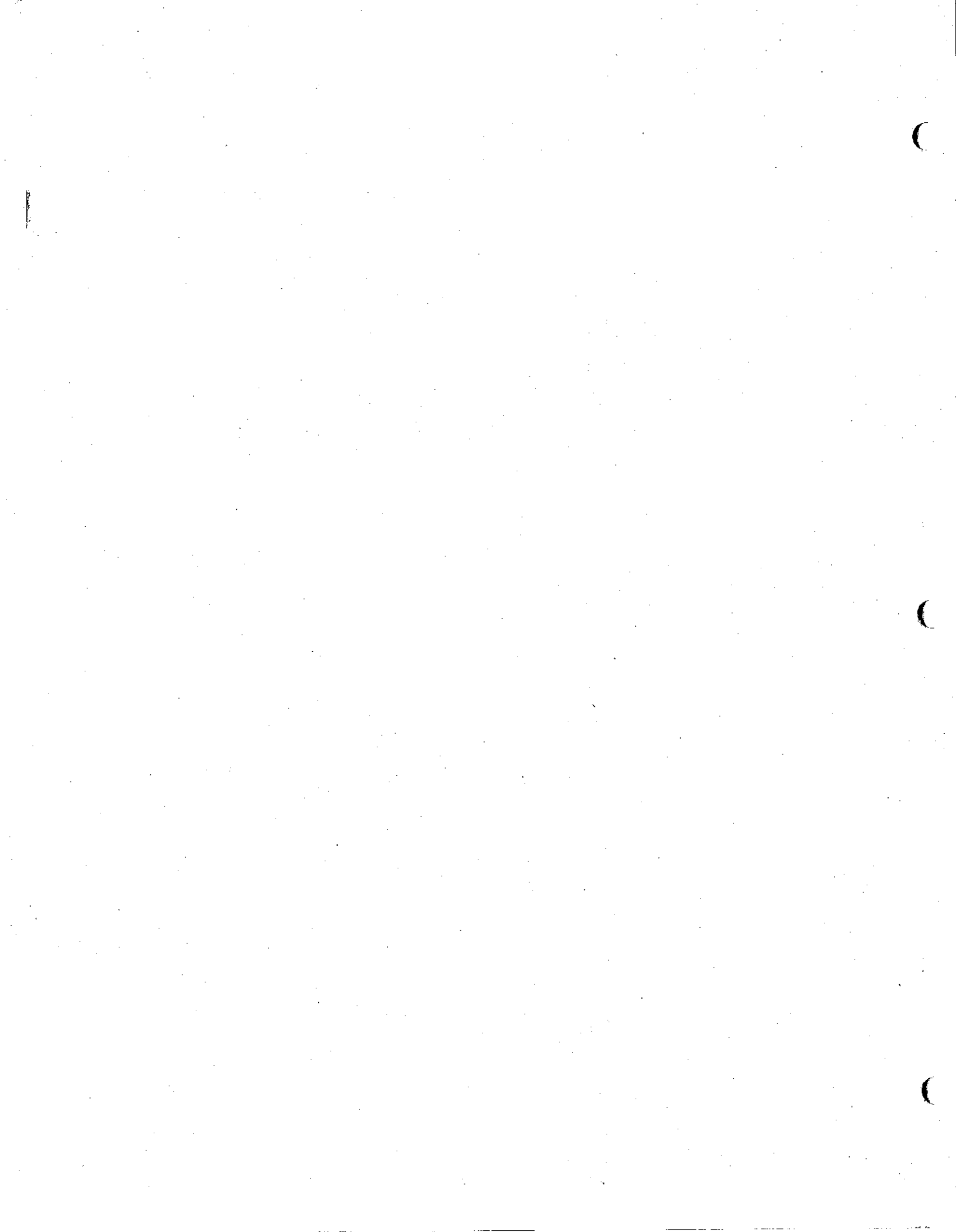

## Section 1

### Goals and Policies

- 1.10 Goals
- 1.20 Planning and Design Principles
  - Service Subsystem
  - Space Demand
  - Effect on Other Subsystems
  - Assessment Principles
  - Multipurpose Use
- 1.30 Planning Requirements
  - Drainage Master Plan
  - Planning Process
    - Minor Drainage Planning
    - Major Drainage Planning
    - Environmental Design
  - Site Planning
  - Water Quality
  - Lower Drainage Costs
  - Open Space
  - Transportation
  - Channelization
  - Channel Storage
  - Major Runoff Capacity
  - Intrabasin Transfer
  - Interbasin Transfer
  - Basin Planning

- Upstream Storage
- Downstream Storage
- 1.40 Design Requirements
  - Design Criteria
  - Criteria Updating
  - Use of Criteria
  - Design Storm Frequencies
  - Initial Storm Provisions
  - Major Storm Provisions
  - Major Drainage Channels
  - Tailwater
  - Storm Runoff
    - Areas Under 200 Acres
    - Areas Over 200 Acres
    - Accuracy
  - Use of Streets
  - Storage Areas
    - Need for Maintenance
    - Water Quality
  - Irrigation Canals
    - Stormwater Conveyance
    - Flood Drainage Liability
- 1.50 Plat Submittal Standards
- 1.60 Implementation

## Section 1

### Goals and Policies

#### 1.10 Goals

The provision of adequate drainage for urban areas is necessary to preserve and promote the general health, welfare, and economic well-being of the City. Drainage is a regional feature that affects all governmental jurisdictions. This characteristic of drainage makes it necessary to formulate a program that balances both public and private interest. Master planning must be integrated on a regional level. It is recommended that such planning be coordinated with state and national agencies, where applicable.

When planning drainage facilities, certain underlying principles provide direction for the effort. These principles are made operational through a set of policy statements. The application of the policy is facilitated by technical criteria and data. When considered in a comprehensive manner, on a regional level with public and private involvement, drainage facilities can be provided to an urban area in a manner that will avoid uneconomic flood losses and disruption, will enhance the general health and welfare of the region, and will assure optimum economic and social benefits.

#### 1.20 Planning and Design Principles

##### Service Subsystem

###### DRAINAGE IS A SUBSYSTEM OF THE TOTAL URBAN SYSTEM

Drainage is a service subsystem for the general urban development in a region. Therefore, the planning of drainage facilities should be in general conformance with the growth management plan which includes land-use designations. This growth management plan has been prepared after consideration of all major elements necessary for proper development of the area and after resolution or compromise of conflicting problems among its elements.

##### Space Demand

###### DRAINAGE IS A SPACE-TIME ALLOCATION PROBLEM

The volume of water present at a given point in time in an urban region cannot be compressed or diminished. It is a space demand which must be considered in the planning process. Because the volume required cannot be altered, choices are limited to locational considerations.

##### Effect on Other Subsystems

Channels and storm sewers serve both a conveyance and storage function. When a channel is planned as a conveyance feature, it requires an outlet to available downstream storage space. When considered as a

space demand, the provision of adequate drainage becomes a competing use for space along with other land uses. If adequate provision is not made in a land-use plan for the drainage demand, stormwater runoff will conflict with other land uses and will result in flood damages, and will impair or even disrupt the functioning of other urban systems.

### Assessment Principles

Space allocation provides the key to workable special assessments to finance drainage facilities. By placing a storage assessment on all property, persons who seek simply to discharge runoff downstream can do so only at a cost: the prorated costs of conveyance and downstream storage.

### Multipurpose Use

AN URBAN DRAINAGE STRATEGY SHOULD BE A MULTIPURPOSE, MULTIPLE MEANS EFFORT

The many competing demands placed upon water within an urban region suggest that a strategy for managing drainage be multipurpose. In addition, facilities not designed primarily for drainage frequently can be designed to provide drainage benefits; e.g., rooftops that provide detention storage. Another aspect of a drainage strategy is that it must consider multiple means of accomplishing its objectives. In general, there is not one single, all-encompassing method of handling stormwater. What is required is a complex combination of conveyance and storage methods and system types. When a multipurpose strategy is adopted in a broad sense, it involves participation by both public and private interests. This, in turn, creates a need for overall supervision and a master plan for drainage.

### 1.30 Requirements

#### Drainage Master Plan

STORM DRAINAGE IS A PART OF THE TOTAL URBAN ENVIRONMENTAL SYSTEM. THEREFORE, STORM DRAINAGE PLANNING AND DESIGN SHALL BE COMPATIBLE WITH COMPREHENSIVE REGIONAL PLANS.

A Drainage Master Plan should be directed by broad, general framework goals. The City of Casper's goals are:

- a. Economic efficiency
- b. Regional development
- c. Environmental preservation and enhancement
- d. Social and recreational needs fulfillment
- e. Responsible funding and implementation policy

These goals, or combinations of these goals, as they are pursued within an urban region, have the potential to influence greatly the type of drainage subsystem selected. Planning for drainage facilities should be related to the goals of the urban region and should be looked upon

as a subsystem of the total urban system, and should not proceed independently of these considerations.

### Planning Process

Good urban drainage planning is a complex process. Fundamentals include:

- a. Initial Drainage Planning. All local and regional planning must take into consideration the initial drainage system to transport the runoff from the storms which can be expected to occur once each 10 years. The initial system provided must assure a minimum of future drainage complaints. The initial drainage system is intended to provide a cost-effective means of conveying storm runoff.
- b. Major Drainage Planning. All local and regional planning must take into consideration the major drainage system necessary to transport the runoff which can be expected to occur every 100 years. The major drainage system planned will prevent loss of life and major damage and will function when the initial drainage system is exceeded.
- c. Environmental Design. Environmental design teams, involving a range of disciplines, shall be convened whenever desirable to ensure that the total system benefits receive consideration in drainage planning. Planning shall include evaluation of the socio-economic impacts of new facilities as well as future operation and maintenance by the public bodies.

### Site Planning

All land development proposals should receive full site planning and engineering analyses. In this regard, a uniform professional consideration must be given to the sites, as outlined in the drainage manual. Where flood hazards are involved, either the City of Casper or the Metropolitan Area Planning Commission shall take into consideration proposed land use so that it is compatible with the flood hazards involved with the property, and appropriate easements shall be provided to preclude encroachment upon waterways or flood storage areas.

### Water Quality

Better quality of the waters of the public streams is an important objective of drainage planning. Sediment and debris collection and removal from stormwater must be taken into account by using detention storage or other means. Sanitary sewerage systems which overflow or bypass untreated sewage into surface streams shall not be permitted. Full cooperation shall be extended to planners and designers of sanitary sewerage works to minimize the hazards involved with the flooding of sanitary sewers by urban storm runoff. Drainage planning shall include means to prevent inflow to sanitary sewers, both because of street flow and flooding of channels. Suitable floodplain

regulations should be a prerequisite for connections to the sanitary sewerage system for new developments.

#### Lower Drainage Costs

THE PLANNING FOR DRAINAGE FACILITIES SHALL BE COORDINATED WITH PLANNING FOR OPEN SPACE, SOLID WASTE DISPOSAL, AND TRANSPORTATION. BY COORDINATING THESE EFFORTS, NEW OPPORTUNITIES ARE IDENTIFIED WHICH CAN ASSIST IN THE SOLUTION OF DRAINAGE PROBLEMS.

The planning of drainage works in conjunction with other urban needs results in more orderly development and lower costs for drainage.

#### Open Space

Open space provides significant urban social benefits. Use of natural drainageways often is less costly than constructing artificial channels. Combining the open space needs of a community with major natural drainageways is a desirable multiple-use strategy which reduces development costs.

#### Transportation

The design and construction of transportation programs relative to new streets and highways should be fully integrated with the drainage needs of the urban area for better streets and highways, better drainage, for avoiding flooding hazards during major storms. The location of borrow pits should be integrated with broad planning objectives, including that of storm runoff detention.

#### Channelization

NATURAL DRAINAGEWAYS SHALL BE USED FOR STORM RUNOFF WATERWAYS WHEREVER POSSIBLE. MAJOR CONSIDERATION MUST BE GIVEN TO THE FLOODPLAINS AND OPENSACE REQUIREMENTS OF THE AREA.

Natural drainageways within an urbanizing area are too often deepened, straightened, lined, and sometimes put underground. A community loses a natural asset when this happens. Channelizing a natural waterway usually speeds up the flow, causing greater downstream peaks and higher drainage costs downstream, and does nothing to enhance the environment. Any channelization or alteration of natural drainageways shall be compatible with the total drainage system.

#### Channel Storage

Drainageways having slow flow, grassy bottoms and sides, and wide water surfaces provide significant storage capacity. This storage is beneficial to the downstream community in that it reduces downstream runoff peaks and provides the opportunity for groundwater recharge. Wide, natural channels provide urban open space.

## **Major Runoff Capacity**

The major drainageways should be capable of carrying the major storm runoff which can be expected to have a one percent chance of occurring in any single year (i.e., the 100-year storm).

## **Intrabasin Transfer**

PLANNING AND DESIGN OF STORMWATER DRAINAGE SYSTEMS SHALL NOT RESULT IN THE TRANSFER OF DRAINAGE PROBLEMS FROM ONE AREA TO ANOTHER.

Channel modifications which create unnecessary problems downstream shall be avoided, both for the benefit of the public and to prevent damage to private parties. Problems to avoid include soil erosion and downstream sediment deposition, alteration of the timing and magnitude of runoff, and conveyance of storm debris.

## **Interbasin Transfer**

The diversion of storm runoff from one basin to another introduces significant legal and social problems and should be avoided unless specific and prudent reasons justify and dictate such a transfer. Prior to reaching a decision, an environmental design team should review all alternatives.

## **Basin Planning**

Master planning must be based upon potential future upstream development, taking into consideration both upstream and downstream future detention and retention storage within the entire drainage basin. These storage facilities shall be assured of construction and successful operation and maintenance.

## **Upstream Storage**

ADDITIONAL STORMWATER RUNOFF SHALL BE STORED IN DETENTION AND RETENTION RESERVOIRS. SUCH STORAGE REDUCES THE DRAINAGE CAPACITY REQUIRED, THEREBY REDUCING THE LAND AREA AND EXPENDITURES REQUIRED DOWNSTREAM. MULTIPURPOSE UTILIZATION OF STORAGE AREAS SHALL BE ENCOURAGED.

Storage of storm runoff close to the points of rainfall occurrence includes use of rooftops, parking lots, ball fields, property-line swales, parks, road embankments, borrow pits, and on-site ponds.

Construction of flat roofs provides excellent on-site storage at little or no cost. All flat roofs shall be designed to store up to three inches of rainfall for retention purposes.

Large parking lots, such as at shopping centers, create rapid runoff with high discharge rates. The same is true for many small parking lots. Parking lots shall provide for storage of runoff except where clearly shown that such storage is impractical.



Wherever reasonably acceptable from a social standpoint, parks should be used for short-term detention of storm runoff to create drainage benefits.

In lieu of providing upstream storage, one may choose to pay additional drainage assessments for downstream drainage works on the basis of runoff contribution.

#### Downstream Storage

The detention and retention of storm runoff in natural channels, in storage reservoirs within the channel, in off-stream reservoirs, and by using planned channel overflow ponding in park and greenbelt areas is desirable.

### 1.40 Design Requirements

#### Design Criteria

STORM DRAINAGE PLANNING AND DESIGN SHALL ADHERE TO THE CRITERIA DEVELOPED AND PRESENTED IN THE CITY DRAINAGE MANUAL.

The design criteria represent sound engineering practice and shall be utilized in the City. The criteria are not intended to be an iron-clad set of rules within which the planner and designer must work; they are intended to serve as guidelines, standards, and methods for sound planning and design.

#### Criteria Updating

The design criteria shall be revised and updated as necessary to reflect advances in the fields of urban drainage engineering and water resources management.

#### Use of Criteria

The governmental agencies and engineers shall utilize the City Drainage Manual in the planning of new facilities, the revision of existing facilities, and in their reviews of proposed drainage plans submitted by developers, private parties, and other governmental agencies, including the State Department of Highways, other elements of the State Government, and the Federal Government.

#### Design Storm Frequencies

EVERY URBAN AREA HAS TWO SEPARATE AND DISTINCT DRAINAGE SYSTEMS, WHETHER OR NOT THEY ARE ACTUALLY PLANNED FOR AND DESIGNED. ONE IS THE INITIAL SYSTEM, AND THE OTHER IS THE MAJOR SYSTEM. TO PROVIDE FOR AN ORDERLY URBAN GROWTH, REDUCE COSTS TO FUTURE GENERATIONS, AND PREVENT LOSS OF LIFE AND MAJOR PROPERTY DAMAGE, BOTH SYSTEMS MUST BE PLANNED AND PROPERLY ENGINEERED.

Storm drainage planning and design shall fully recognize the need for considering two separate and distinct storm drainage systems; i.e., the initial drainage system and the major drainage system. Design storm frequencies shall be as stated in this Manual for various project components.

There are many developed areas within the City of Casper which do not conform to the drainage standards projected in this Manual. It is recognized that the upgrading of these developed areas to conform to all of the policy, criteria, and standards contained in this manual will be difficult to obtain, short of complete redevelopment or renewal.

The strict application of this Manual in the overall planning of new development is practical and economical; however, in the planning of drainage improvements and the designation of floodplains for developed areas, the use of the criteria and standards contained in the Manual may be adjusted as determined by the appropriate agency.

#### Initial Storm Provisions

The initial storm drainage system is necessary to reduce street maintenance costs, to provide protection against the 10-year frequency damage from storm runoff, to help design and implement an orderly urban system, and to provide convenience to the urban residents. The initial drainage system cannot economically carry major runoff, though the major drainage system can provide for the 10-year storm runoff. Storm sewer systems consisting of underground pipes are a part of initial storm drainage systems. A well-planned major drainage system can reduce the need for storm sewer systems.

#### Major Storm Provisions

In addition to providing the storm drainage facilities for the initial storm runoff, provisions shall be taken to prevent major property damage and loss of life for the storm runoff expected to occur once each 100 years. Such provisions are known as the major drainage system. Where the 100-year storm is not selected for design purposes, the impact of the 100-year storm shall be investigated and reported.

#### Major Drainage Channels

Open channels for conveyance of major storm runoff are desirable in urban areas, and use of such channels is recommended.

Optimum benefits from open channels can best be obtained by incorporating parks and greenbelts with the channel layout. Open channels should follow the natural flowlines and should receive early attention in planning stages of a new development, along with other storm runoff features.

Natural watercourses, perhaps wet only during and after large rainstorms, must not be filled, straightened, or altered significantly.

Such actions tend to reduce capacity and storage and increase the velocity to the detriment of those downstream as well as those adjacent to the channel work. Effort must be made to reduce flood peaks and control erosion so that the natural channel is preserved as much as possible.

#### Tailwater

The depth of flow in the receiving stream must be taken into consideration for backwater computations for either the initial or major storm runoff.

#### Storm Runoff

THE DETERMINATION OF RUNOFF MAGNITUDE SHALL BE BY EITHER THE RATIONAL FORMULA, THE COLORADO URBAN HYDROGRAPH PROCEDURE, OR STATISTICAL ANALYSES BASED ON ACTUAL MEASURED FLOOD OCCURRENCES.

#### Areas under 200 Acres

The Rational Formula shall be the method used to compute the peak discharge of storm runoff for basins less than 200 acres in size.

The Colorado Urban Hydrograph Procedure is useful for checking of the Rational Formula results to insure reasonableness. It shall also be used for the analysis of runoff storage for areas larger than 20 acres.

#### Areas over 200 Acres

The Colorado Urban Hydrograph Procedure (CUHP) shall be used for computing the storm runoff hydrograph for drainage areas over 200 acres in size. However, the sub-basins making up the total area, when less than 200 acres, may be studied using the Rational Formula.

The CUHP provides a means for adequately evaluating times of concentration from various sub-basins for the sizing of channels, trunk lines, and outfalls, and for studying the effect of detention and retention storage for all sub-basins greater than 20 acres in size.

#### Accuracy

The peak discharges determined by either of the two methods are approximations. Rarely will the drainage system operate at the design discharge. Flow will always be more or less in actual practice, merely passing through the design flow as it rises and falls. Thus, the engineer should not overemphasize the accuracy of his computed discharges. He should emphasize the design of a practical and hydraulically balanced system based on sound logic and engineering as well as on dependable hydrology.

## Use of Streets

USE OF STREETS FOR URBAN DRAINAGE SHALL FULLY RECOGNIZE THAT THE PRIMARY USE OF STREETS IS FOR TRAFFIC. STREETS SHALL NOT BE USED AS FLOODWAYS FOR INITIAL STORM RUNOFF TO THE EXCLUSION OF TRAFFIC. URBAN DRAINAGE DESIGN SHALL HAVE AS AN OBJECTIVE THE REDUCING OF STREET REPAIR AND MAINTENANCE COSTS TO THE PUBLIC.

Streets are significant and important in urban drainage, and full use shall be made of streets for storm runoff up to reasonable limits, recognizing that the primary purpose of streets is for traffic. Reasonable limits of the use of streets for conveying storm runoff shall be governed by the design criteria listed below:

### ALLOWABLE USE OF STREETS FOR INITIAL STORM RUNOFF IN TERMS OF PAVEMENT ENCROACHMENT

<u>Street Classification</u>	<u>Maximum Encroachment</u>
Local	No curb overtopping. Flow may spread to crown of street.
Collector	No curb overtopping. Flow spread must leave at least one lane free of water.
Arterial	No curb overtopping. Flow spread must leave at least one lane free of water in each direction.
Freeway	No encroachment is allowed on any traffic lanes.

When the above encroachment is indicated, the storm sewer system shall commence, designed on the basis of the initial storm. Development of the major drainage system is encouraged to quickly drain the initial runoff from the streets, thus moving the point at which the storm sewer system shall commence further downstream.

While it is the intent of this policy to have major storm runoff removed from public streets at frequent and regular intervals into major drainageways, it is recognized that water will often tend to follow streets and roadways, and that streets and roadways often may be aligned so that they will provide a specific runoff conveyance function. Planning and design objectives for the major drainage system with respect to public streets shall be based upon the following limiting criteria:

**MAJOR STORM RUNOFF ALLOWABLE STREET INUNDATION**

<u>Street Classification</u>	<u>Allowable Depth and Inundated Areas</u>
Local and Collector	Residential dwellings, public, commercial, and industrial buildings shall not be inundated at the ground line, unless buildings are flood-proofed. The depth of water over the gutter flowline shall not exceed 18 inches.
Arterial and Freeway	Residential dwellings, public, commercial, and industrial buildings shall not be inundated at the ground line, unless buildings are flood-proofed. Depth of water at the street crown shall not exceed 6 inches in order to allow operation of emergency vehicles. The depth of water over the gutter flowline shall not exceed 18 inches.

The allowable flow across streets shall be limited to be within the following criteria:

**ALLOWABLE CROSS STREET FLOW**

<u>Street Classification</u>	<u>Initial Design Runoff</u>	<u>Major Design Runoff</u>
Local	6 inches of depth in cross pan	18 inches of depth above gutter flowline
Collector	Where cross pans are allowed, depth of flow shall not exceed 6 inches	18 inches of depth above gutter flowline
Arterial	NONE	6 inches or less over crown
Freeway	NONE	6 inches or less over crown

In general, an arterial street crossing will require that a storm sewer system be commenced, unless the topography is such that daylighted inlet culverts or other suitable means can transport the initial storm runoff under the arterial street. Collector streets shall have cross pans only at infrequent locations, as specified by the governing agency and in accordance with good traffic engineering practices.

## **Storage Areas**

DETENTION AND RETENTION STORAGE AREAS SHALL HAVE A RELEASE RATE FOR THE 10-YEAR, 2-HOUR STORM WHICH DOES NOT EXCEED THE NATURAL RUNOFF RATE. THE DESIGN OF ALL IMPOUNDMENTS, WHETHER TEMPORARY OR PERMANENT, MUST BE APPROVED BY THE STATE ENGINEER OF WYOMING. AN ORDINANCE HAS BEEN ADOPTED BY THE CITY OF CASPER TO INSURE THE PROPER FUNCTIONING OF THESE STORAGE AREAS TO AVOID PUBLIC NUISANCES AND HEALTH AND SAFETY HAZARDS.

### **Need for Maintenance**

Maintenance of storage reservoirs entails the removal of debris and sediment. This is seldom done, however, because of the cost of removal and the difficulty of finding a disposal site. Without adequate funding and a commitment by the governmental agency for proper maintenance, a storage reservoir will become unsightly, a social liability, and eventually ineffective as a detention basin.

### **Water Quality**

Detention and retention reservoirs provide an opportunity to improve the quality of the stormwater before it reaches classified streams of the State of Wyoming.

## **Irrigation Canals**

### **Stormwater Conveyance**

WHEN URBAN DEVELOPMENT ENCROACHES UPON EXISTING IRRIGATION FACILITIES, THE CITY SHALL SEEK TO MINIMIZE THE ADVERSE EFFECT OF NEW DEVELOPMENT AND TO LIMIT THE LIABILITY OF IRRIGATION FACILITY OWNERS.

Irrigation canals often capture stormwater from upstream areas. Urban development tends not only to increase the volume and the flowrate of storm runoff, but also to decrease the time required to reach a peak rate. In addition, the concentration patterns of runoff may be changed. The net effect of urbanization is usually an increase in peak flowrate received downstream.

The use of irrigation canals for stormwater conveyance generally is not acceptable since the capacity of canals decreases downstream, and the slopes, which tend to be small, lessen the stormwater transport capabilities.

Since ditch owners can be held liable in case of ditch failure during intense rainfall events, acceptance of increased runoff may aggravate problems for ditch systems. Occasionally, however, the only alternative is to direct runoff into existing ditches.

Wherever new development will alter patterns of drainage into irrigation ditches by increasing flowrates or volumes, or will change the historic concentration points of runoff, each new development shall obtain written consent from canal owners before approval of an application. The discharge of runoff into irrigation ditches shall

be approved only if such discharge is consistent with the appropriate master plan.

Problems with drainage into canals often can be avoided if storm runoff is directed into natural and historic drainageways, and the irrigation canals are not used.

Runoff from new urban development shall be directed into historic and natural drainageways, avoiding discharge into canals, except as required by water rights or where no reasonable alternative exists.

#### Flood Damage Liability

Canals often intercept natural drainageways that are part of the major drainage system. In these cases, canals may have water rights to allow the canal to capture daily flows. Irrigation facilities may, however, suffer considerable damage in the event of a major storm, which might cause flood damage due to failure of the canal at some undetermined point downstream.

Wherever irrigation canals intercept major drainage channels in developing areas, the developer shall separate peak storm runoff flows from normal canal flows whenever such separation is economically feasible and meets proper engineering standards.

#### Erosion and Sediment Control

THE NEED FOR SEDIMENT AND EROSION CONTROL FACILITIES, EITHER PERMANENT OR TEMPORARY, SHALL BE DETERMINED ACCORDING TO THE STANDARDS FOR SEDIMENT AND EROSION CONTROL IN DEVELOPING AREAS, AS STATED IN THIS MANUAL.

A Temporary Erosion and Sediment Control Plan is required unless otherwise approved by the City Engineer.

The temporary erosion and sedimentation control facility shall be constructed prior to any grading or extensive land clearing, in accordance with the above plan. These facilities must be satisfactorily maintained until construction and landscaping are completed and the potential for on-site erosion has passed.

#### 1.50 Plat Submittal Standards

Plans and profiles shall be drawn on sheets 24" x 36" to a horizontal scale of 1" to 50' and a vertical scale of 1" to 2' or 1" to 5' (except that scales may vary on special projects, such as culverts and channel cross sections).

Good-quality reproducibles of the original drawings shall be presented to the City of Casper Engineering Department prior to the receipt of final approval and shall remain the permanent property of the City of Casper.

Stationing shall proceed upstream with the north arrow pointing to the top of the sheet, or to the left.

Plans for the proposed drainage system shall include property lines, lot and block numbers, dimensions, right-of-way and easement lines, floodplains, street names, paved surfaces (existing or proposed), location, size and type of inlets, manholes, culverts, pipes, channels, and related structures, contract limits, outfall details, miscellaneous riprap construction, contour lines, and title block.

Profiles shall indicate the proposed system (size and material) with elevations, flowlines, gradients, left and right bank channel profiles, station numbers, inlets, manholes, ground-line and curb-line elevations, typical sections, riprap construction, filling details, minimum permissible slab elevations within 100-year floodplains and adjacent to open drainage features, pipe crossings, design flow capacities, and title block.

#### 1.60 Implementation

THIS DRAINAGE MANUAL IS RECOMMENDED FOR ADOPTION BY ALL GOVERNMENTAL UNITS OPERATING WITHIN THE AREA.

EACH LEVEL OF GOVERNMENT SHOULD PARTICIPATE IF THE DRAINAGE PROGRAM IS TO BE SUCCESSFUL.

URBAN DRAINAGE PROBLEMS ENCOUNTERED BY ANY GOVERNMENTAL UNIT SHOULD BE REVIEWED BY THE CITY TO DETERMINE IF EQUITY OR PUBLIC INTERESTS INDICATE A NEED FOR AMENDMENTS TO DRAINAGE POLICY, PRACTICE, OR PROCEDURES.

THE FINANCING OF STORM DRAINAGE IMPROVEMENTS IS FUNDAMENTALLY THE RESPONSIBILITY OF THE AFFECTED PROPERTY OWNERS: BOTH THE PERSON DIRECTLY AFFECTED BY THE WATER AND THE PERSON FROM WHOSE LAND THE RUNOFF ORIGINATES.



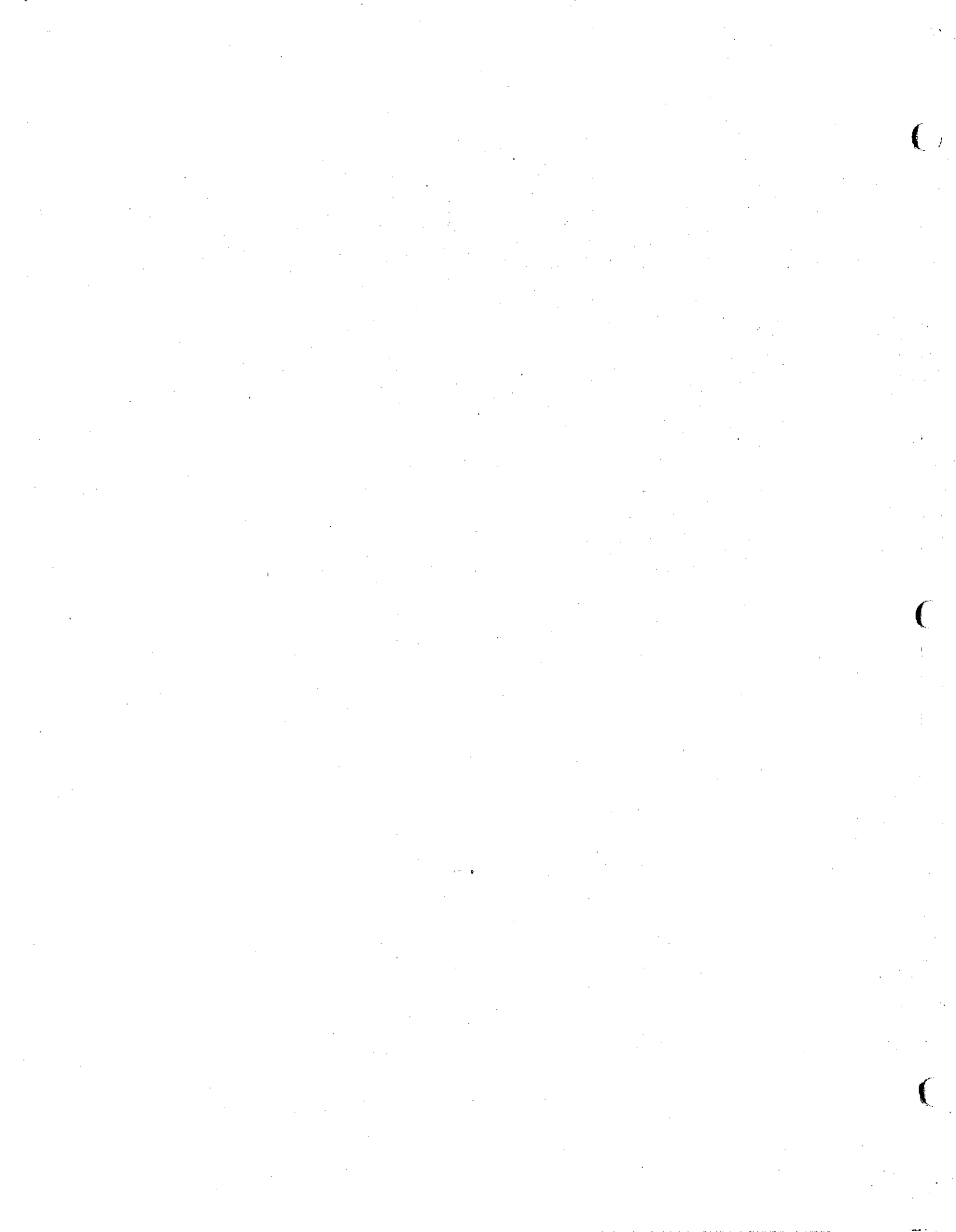

## Section 2

### Storm Runoff

- 2.10 Rational Method
  - Runoff Coefficient
  - Rainfall Intensity
  - Time of Concentration
    - Overland Flow
    - Storm Sewer or Road Gutter Flow
    - Channel Flow
- 2.20 Colorado Urban Hydrograph Procedure
  - Limitations
  - Definition of Terms
  - Basin Characteristics
    - Lag Time
    - Time to Peak
    - Peak Discharge
    - Dimensionless Unit Hydrograph
  - Design Storm
    - Rainfall Distribution
    - Losses
    - Rainfall Excess
    - Runoff Hydrograph
- 2.30 Bibliography

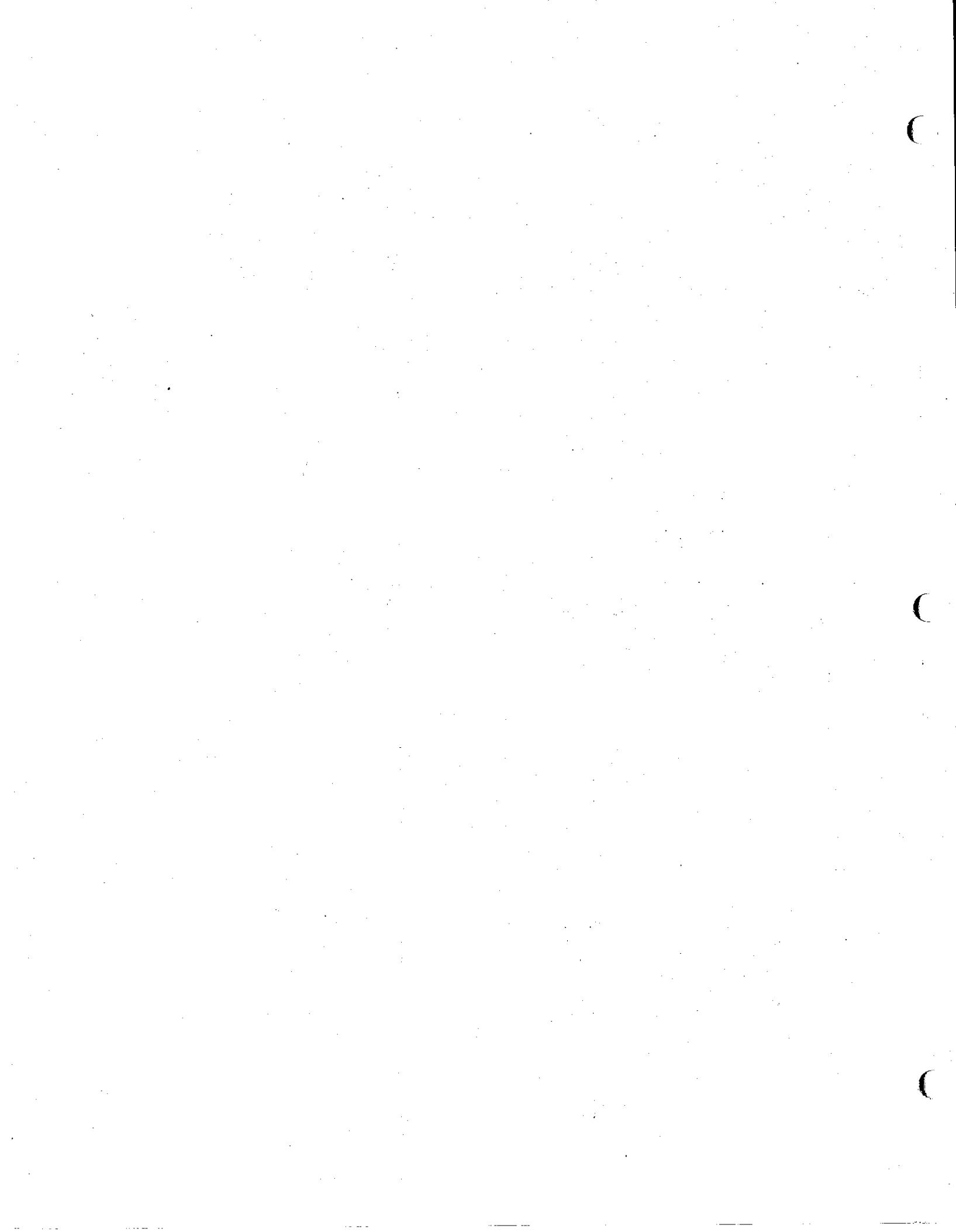

## Section 2

### Storm Runoff

This section presents two methods for computing storm runoff in the Casper region. The Rational Method is the primary tool for the determination of runoff from areas of 200 acres or less and is especially useful for the design of storm sewer systems. The Colorado Urban Hydrograph Procedure is a more complex procedure which provides for the determination of storm runoff hydrographs for drainage areas greater than 200 acres. This method is used to quantify the effects of urbanization, to determine peak flows for large drainage areas, and to design stormwater storage facilities (for drainage areas greater than 20 acres). The presentation of these two methods is not intended to preclude the use of other methods; however, the designer is advised to secure approval from the appropriate reviewing agencies before utilizing different methods.

#### 2.10 Rational Method

The Rational Method is an empirical runoff formula which has gained wide acceptance because of its simple, intuitive treatment of storm runoff. This method relates peak runoff to rainfall intensity, surface area, and surface characteristics by the formula:

$$Q = C_f C_i A \quad (2-1)$$

where:

- Q = peak runoff rate, in cubic feet per second (cfs);
- C = runoff coefficient representing a ratio of peak runoff rate to average rainfall intensity for a duration equal to the time of concentration;
- C<sub>f</sub> = correction factor to adjust the runoff coefficient for less-frequent, high-intensity storms;
- i = average rainfall intensity, in inches per hour; and
- A = drainage area, in acres.

The Rational Method is based on the following assumptions:

1. The peak rate of runoff at any point is a direct function of the average uniform rainfall intensity during the time of concentration to that point.
2. The frequency of the peak discharge is the same as the frequency of the average rainfall intensity.

3. The time of concentration is the time required for the runoff to become established and flow from the most hydraulically remote part of the drainage area to the point under design. This assumption applies to the most remote in time, not necessarily in distance.

Although the basic principles of the Rational Method apply to drainage areas greater than 200 acres, practice generally limits its use to some maximum area. For larger areas, storage and subsurface drainage flow cause an attenuation of the runoff hydrograph so that the rates of flow tend to be overestimated by the Rational Method. In addition, the assumption of uniform rainfall distribution and intensity becomes less appropriate as drainage area increases. Because of the trend for overestimation of flows and the additional cost in drainage facilities associated with this overestimation, the application of a more sophisticated runoff computation technique is usually warranted on larger drainage areas. The designer should obtain permission from the appropriate agency before applying the Rational Method to areas larger than 200 acres. Refer to Section 1.40 for a more detailed discussion of design criteria.

#### Runoff Coefficient

The runoff coefficient,  $C$ , is a variable of the Rational Method which is least susceptible to a precise determination and provides the designer with a degree of latitude to exercise his independent judgment. The following discussion is intended to provide a guide to promote the uniform application of runoff coefficients.

The runoff coefficient accounts for abstractions for losses between rainfall and runoff which may vary with time for a given drainage area. These losses are caused by interception by vegetation, infiltration into permeable soils, retention in surface depressions, and evaporation and transpiration. In determining this coefficient, differing climatological and seasonal conditions, antecedent moisture conditions, and the intensity and frequency of the design storm should be considered.

Table 2-1 presents recommended  $C$  values. Where ranges are shown, adjustments should be made for level of development, surface type, soil type, and slope. It is often desirable to develop a composite runoff coefficient based in part on the percentage of different types of surfaces in the drainage area. This procedure can be applied to typical "sample" areas as a guide to the selection of usual values of the coefficient for the entire area. Suggested coefficients with respect to surface types are given in Table 2-2.

TABLE 2-1

## Recommended Runoff Coefficients

<u>Land Use</u>	<u>Runoff Coefficient</u>	
Business		
Downtown	0.70 to	0.95
Neighborhood	0.50 to	0.70
Residential		
Single-family	0.30 to	0.50
20,000 sq. ft.	0.49	
10,000 sq. ft.	0.52	
8,500 sq. ft.	0.57	
Multi-units, detached	0.40 to	0.60
Multi-units, attached	0.60 to	0.75
Residential (ranch-type)	0.25 to	0.40
Apartment	0.50 to	0.70
Industrial		
Light	0.50 to	0.80
Heavy	0.60 to	0.90
Parks and Cemeteries	0.10 to	0.25
Playgrounds	0.20 to	0.35
Railroad Yard	0.20 to	0.35
Unimproved	0.10 to	0.30

TABLE 2-2

## Suggested Runoff Coefficients for Surface Types

<u>Character of Surface</u>	<u>Runoff Coefficients</u>
Pavement	
Asphaltic and Concrete	0.95
Brick	0.85
Roofs	0.95
Turf	
Flat, 0 to 1%	0.25
Average, 1 to 3%	0.35
Hilly, 3 to 10%	0.40
Steep, 10%+	0.45
Cultivated Ground	
Flat, 0 to 1%	0.10
Average, 1 to 3%	0.20
Hilly, 3 to 10%	0.25
Steep, 10%+	0.30

The coefficients in these two tables are applicable for a 10-year storm. These coefficients are based on the assumption that the design storm does not occur when the ground surface is frozen or covered by melting snow. Table 2-3 presents correction factors to adjust the above runoff coefficient for the 100-year storm.

TABLE 2-3

## Frequency Factors for the Rational Formula

<u>Recurrence Interval (years)</u>	<u>Adjustment Factor <math>C_f</math></u>
10	1.00
100	1.25*

\* $C_x C_f$  should not exceed 1.0

## Rainfall Intensity

Rainfall intensity,  $i$ , is the average rate of rainfall, in inches per hour. Intensity is selected on the basis of design frequency of exceedence, a statistical parameter established by design criteria, and rainfall duration. For the rational method, the critical rainfall intensity is the rainfall having a duration equal to the time of concentration of the drainage basin.

Rainfall intensity can be determined for the 10-year and 100-year return periods from Figure 2-1. This figure was compiled from the National Oceanic and Atmospheric Administration (NOAA) Atlas 2, Precipitation- Frequency Atlas of the Western United States, Volume II - Wyoming (1973). These curves are applicable for durations from 5 to 120 minutes.

## Time of Concentration

One of the basic assumptions underlying the rational method is that runoff is a function of the average rainfall rate during the time required for water to flow from the most hydraulically remote point of the drainage basin to the point under consideration. Time of concentration is usually computed by determining the travel time through the watershed. Overland flow, storm sewer or road gutter flow, and channel flow are the three phases of direct flow commonly used in computing travel time.

## Overland Flow

The travel time for overland flow consists of the time it takes water to travel from the uppermost part of the watershed to a defined channel or inlet of the storm sewer system. Overland flow is significant in small watersheds because a high proportion of travel time is due to overland flow. The velocity of overland flow can vary greatly with the surface cover and tillage. If the slope and land use of the overland flow segment are known, the travel time can be read from Figure 2-2 or calculated using the following equation:

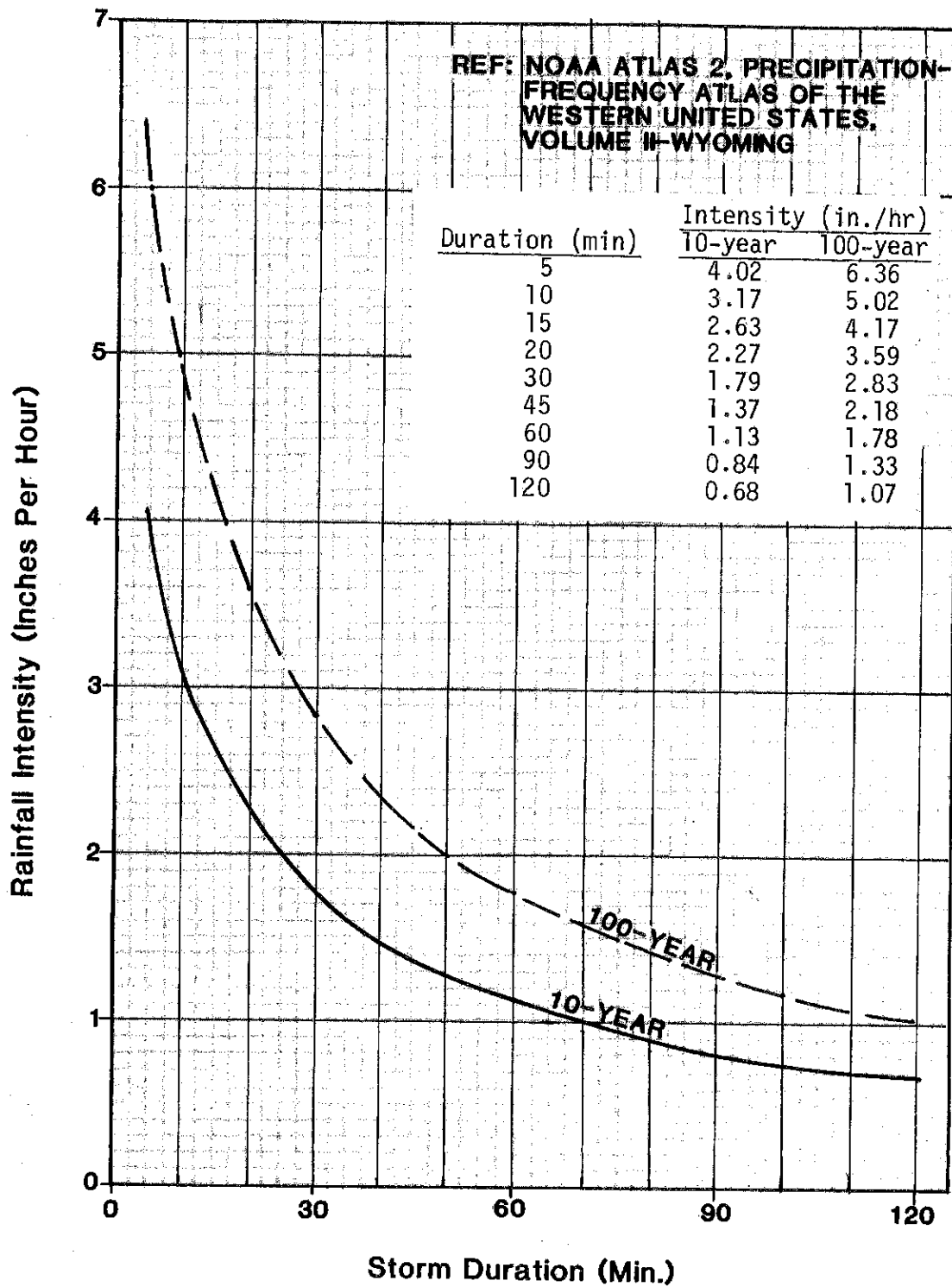

Figure 2-1 Rainfall Intensity -Duration Curves



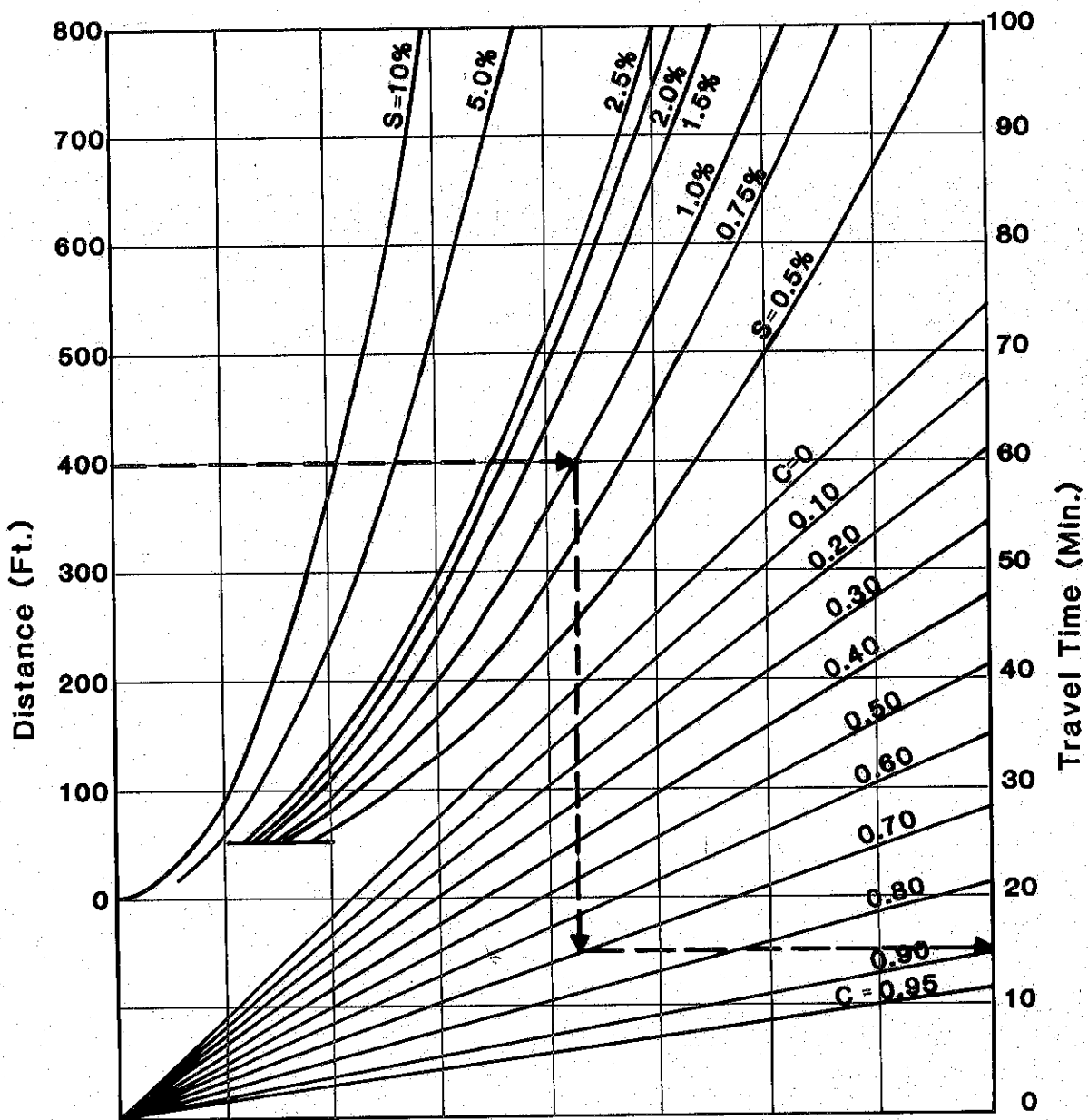

Figure 2-2

Overland Flow Curves

$$T = 1.87 (1.1 - CC_f) L^{0.5} S^{-0.33} \quad (2-2)$$

where:

T = travel time, in minutes;

CC<sub>f</sub> = adjusted runoff coefficient;

L = length of overland flow, in feet; and

S = slope of flow path, in percent.

Times of concentration calculated for fully developed land use should not be less than 5 minutes to avoid the oversizing of inlets, storm sewers, and open channels.

Overland flow length should not exceed 300 feet for developed areas or 1,000 feet for undeveloped areas before being intercepted by a defined channel or storm sewer inlet. Beyond these distances use gutter flow or channel flow velocities using Manning's Formula.

#### Storm Sewer or Road Gutter Flow

Travel time through the storm sewer or road gutter system to the main open channel is the sum of travel times in each individual component of the system between the uppermost inlet and the outlet. In most cases average velocities can be used without a significant loss of accuracy. During major storm events, the sewer system may be fully taxed and additional channel flow may occur, generally at a significantly lower velocity than the flow in the storm sewers. By using the average conduit size and the average slope (excluding any vertical drops in the system), the average velocity can be estimated using Manning's Formula. Refer to Sections 3 and 7 for further information on Manning's Formula.

Since the hydraulic radius of a pipe flowing half full is the same as when flowing full, the respective velocities are equal. Travel time may be based on the pipe flowing full or half full. The travel time through the storm sewers is computed by dividing the length of flow by the average velocity.

#### Channel Flow

The travel time for flow in an open channels can be determined by using Manning's formula to compute average velocities. Bankfull velocities should be used to compute these averages. Channels may be in either natural or improved condition.

#### Example 1

A model urbanized watershed is shown in Figure 2-3. Three types of flow exist from the furthestmost point of the watershed to the outlet. Compute time of concentration (T<sub>C</sub>) based on the following data:

Reach	Description of Flow	Slope Percent	Length Feet
A to B	Overland (park, C = 0.2)	7	500
B to C	Overland (shallow gutter, C = 0.95)	2	900
C to D	Storm sewer (n = 0.015; diameter = 3 feet)	1.5	2,000
D to E	Open channel, gunite, trapezoidal (b = 5 ft; d = 3 ft; r = 1.78 ft; z = 1; n = 0.019 ft)	0.5	3,000

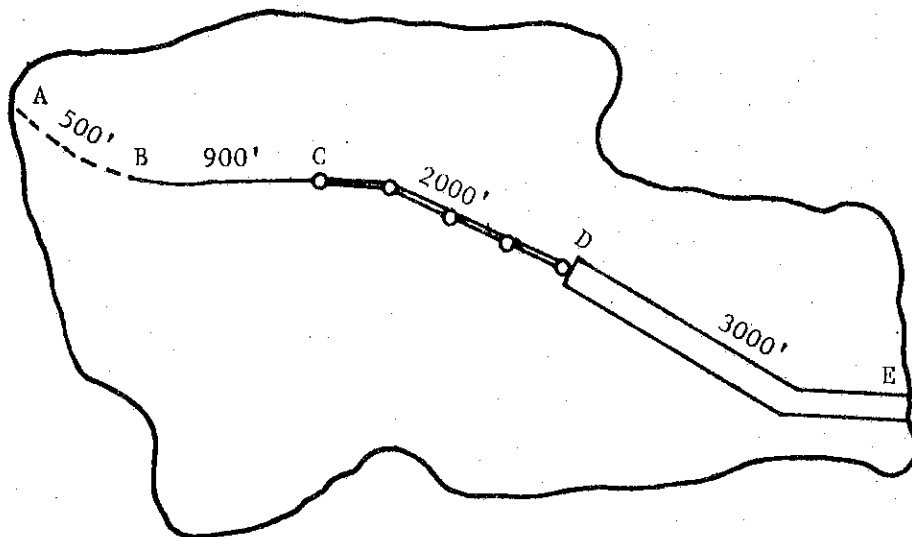

Figure 2-3 Urban Watershed

1. Compute the overland flow travel time.  
Reach A to B (park). From Figure 2-2 for a slope of 7 percent, length of 500 feet, and C = 0.2, read T = 19.7 min = 1180 sec.

Reach B to C (street gutter). From Equation 2-2 for a slope of 2 percent, length of 900 feet, and C = 0.95, find T = 6.7 min = 400 sec.

2. Compute the storm sewer flow travel time.  
Reach C to D. Use Manning's equation to compute full-pipe velocity.

$$v = \frac{1.49}{n} \left( \frac{d}{4} \right)^{2/3} s^{1/2}$$

$$v = \frac{1.49}{0.015} \left( \frac{3}{4} \right)^{2/3} (0.015)^{1/2} = 10 \text{ ft/sec}$$

$$T = \frac{\text{length}}{\text{velocity}} = \frac{2,000 \text{ ft}}{10 \text{ ft/sec}} = 200 \text{ sec}$$

3. Compute the open-channel flow travel time.  
Reach D to E. Use Manning's formula to compute bankfull velocity.

$$v = \frac{1.49}{n} r^{2/3} s^{1/2}$$

$n = 0.019$  for gunite channel

$s = 0.005$

$$v = \frac{1.49}{0.019} (1.78)^{2/3} (0.005)^{1/2} = 8.14 \text{ ft/sec}$$

$$T = \frac{\text{length}}{\text{velocity}} = \frac{3,000 \text{ ft}}{8.14 \text{ ft/sec}} = 369 \text{ sec}$$

#### 4. Summary

<u>Reach</u>	<u>Description of flow</u>	<u>Length (ft)</u>	<u>Velocity (ft/sec)</u>	<u>Travel Time (sec)</u>
A to B	Overland	500	0.42	1180
B to C	Overland	900	2.25	400
C to D	Storm Sewer	2,000	10.00	200
D to E	Open Channel	3,000	8.15	369
Total		6,400	2.98 (avg)	2149

$$T_c = \frac{2,149 \text{ sec}}{60 \text{ sec/min}} = 36 \text{ min}$$

#### 2.20 Colorado Urban Hydrograph Procedure

In 1977 the Denver Regional Council of Governments adopted a method of computing runoff hydrographs based on actual rainfall and runoff measurements. The Colorado Urban Hydrograph Procedure (CUHP) reflects the analysis of data obtained between 1967 and 1973 on 19 urban watersheds in the Denver-Boulder metropolitan region. The statistical analysis involved ninety-six 5-minute hydrographs derived from flood events on those watersheds.

##### Limitations

The major constraint upon the use of the CUHP is that each individual basin should be no larger than 10 square miles and preferably between 20 and 2000 acres. This manual requires the use of the CUHP for any basin larger than 200 acres (20 acres for storage analysis).

Another significant limitation is that of basin elevation. Because few recorded hydrographs for high elevations are available, it is recommended that the CUHP be used with caution when the mean elevation of the basin exceeds 6,000 feet mean sea level.

## Definition of Terms

The following definitions of terms are included to provide a better understanding of the Colorado Urban Hydrograph Method.

**Design Rainfall Distribution:** A critical arrangement of twenty-four 5-minute rainfall increments, centering the greatest 5-minute increment at the midpoint, which represent the 2-hour storm of a specified frequency.

**Dimensionless Unit Hydrograph:** A hydrograph made to represent many unit hydrographs by using the time to peak and the peak discharge as basic units and plotting the hydrographs in ratios of these units.

**Drainage Area, A:** The total area that contributes directly to surface runoff, in square miles.

**Depression Storage:** An accumulated precipitation loss, in inches, which is satisfied only when the rainfall rate exceeds the infiltration rate for a particular 5-minute rainfall increment.

**Infiltration:** A constant precipitation loss, in inches which occurs during each 5-minute rainfall increment.

**Impervious Area, I:** The percentage of area within a basin through which water infiltrates with great difficulty. Typical impervious surfaces include parking lots, roads, and roofs.

**Lag Time,  $t_p$ :** Time to the unit hydrograph peak from the midpoint of unit rainfall excess, in hours.

**Length, L:** Distance of the main channel or flow path from the point of study, to the upstream basin divide, in miles.

**Length to Centroid,  $L_c$ :** Distance of the main channel or flow path from the point of study to a point opposite the basin centroid, in miles. The centroid is equivalent to the center of mass of a planar representation of the basin, and may be located by graphical or numerical methods.

**Peak Discharge,  $Q_p$ :** The maximum rate of runoff calculated for the 5-minute unit hydrograph, in cubic feet per second (cfs).

**Rainfall Excess:** Five-minute precipitation increments minus depression storage and infiltration losses, in inches.

**Runoff Hydrograph:** The product of the unit hydrograph ordinates multiplied by the amount of unit rainfall excess for each 5-minute increment. Hydrographs resulting from the 5-minute increments of rainfall excess are lagged in time by 5 minutes and added together.

**Slope, S:** The average slope of the watershed, in percent. The following relation may be used to determine average slope.

$$S = \frac{H}{(0.8L)5280} \times 100 \quad (2-3)$$

where:

H = the difference in elevation between the 0.8L elevation and the elevation at the point of study, in feet; and

L = length, in miles.

Time to Peak,  $T_p$ : The time from the beginning of rainfall excess to the unit hydrograph peak, in hours. This equals the lag time plus one-half of the 5-minute rainfall increment.

Unit Hydrograph: The hydrograph having a volume of 1 inch of runoff from a 5-minute increment of rainfall excess.

### Basin Characteristics

The hydrologic response of a watershed to rainfall events changes as a result of urban development. Man-made improvements such as buildings, paved streets, and parking lots reduce infiltration into the ground and increase both the volumes and peak rate of runoff. The degree to which these changes will impact the basin runoff characteristics can be determined using parameters describing stages of development. The extreme development stages will be the basin's natural condition and the ultimately developed condition. Natural condition is defined as void of any development. Ultimate condition describes the basin's fully developed state.

### Lag Time

Two basic equations are used in defining the shape of the unit hydrograph. The first equation defines the lag time of the basin,  $t_p$ , or the time from the midpoint of unit rainfall excess to the unit hydrograph peak,  $q_p$ . The duration of unit rainfall excess equals 5-minutes. The equation for  $t_p$ , in hours, is:

$$t_p = C_t(LL_c)^{0.3} \quad (2-4)$$

where:

L = length along the main channel or flow path from the point of study to the basin divide, in miles;

$L_c$  = length along the main channel or flow path from the point of study to a point opposite the basin centroid, in miles; and

$C_t$  = a coefficient reflecting the basin lag time.

Values of  $C_t$  as a function of the percentage of impervious area within a basin,  $I$ , are shown in Figure 2-4. Thus, the shape of the unit hydrograph is directly related to the degree of urbanization within a watershed. Table 2-4 shows values of  $I$  for various classes of land use. Select fully developed values for ultimate conditions and a value corresponding to predevelopment land use for natural conditions.

TABLE 2-4

Values of I for Ultimately Developed Areas

<u>Land Use</u>	<u>I (%)</u>
Average Lot Size (Sq. Feet)	
0 to 5,000	65
5,000 to 10,000	38
10,000 to 15,000	30
15,000 to 20,000	25
20,000 +	20
Apartment Areas, Commercial and Business Areas	85
Industrial Districts	72
Paved Parking Lots and Roads	100
Gravel Parking Lots and Roads	63
Agricultural, Park, and Recreational Areas	0-10
Open Space and Woodlands	0-5

Adjustments to  $C_t$  are necessary for either very flat or very steep slopes as shown by the following equations:

$$C_t = 0.40 C_{t_0} S^{-0.2} \text{ for } S < 0.01 \text{ ft/ft} \quad (2-5)$$

$$C_t = 0.48 C_{t_0} S^{-0.2} \text{ for } S > 0.025 \text{ ft/ft} \quad (2-6)$$

where:

$C_{t_0}$  = unadjusted value of  $C_t$ ; and

$S$  = average slope of the lower 80 percent of the main channel or flow path to the point of study, in feet per foot. (See Definitions of Terms in this Section.)

Time to Peak

The time to peak, in hours,  $T_p$ , is the time from the beginning of rainfall excess to the unit hydrograph peak. Since lag time,  $t_p$ , differs from time to peak,  $T_p$ , by one-half the rainfall excess duration,  $D$ , the equation for  $T_p$  is:

$$T_p = t_p + \frac{D}{2} = t_p + \frac{5}{2(60)} = t_p + 0.0417 \quad (2-7)$$

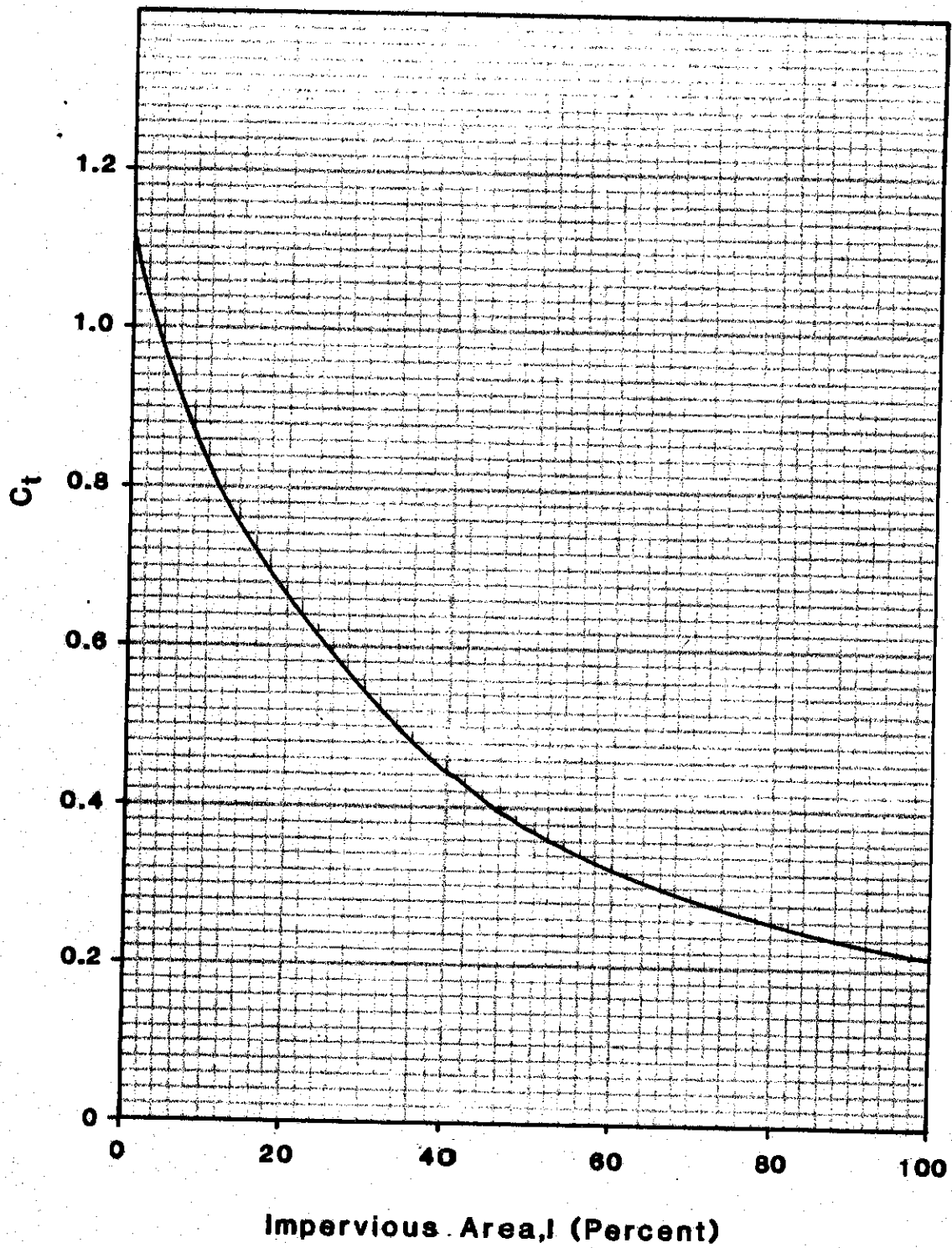

Figure 2-4 Relationship of I to C<sub>t</sub>





## Peak Discharge

The second equation defines the peak of the unit hydrograph,  $q_p$ . The equation for  $q_p$ , in cfs per inch of runoff, is:

$$q_p = \frac{640 C_p A}{t_p} \quad (2-8)$$

where:

A = drainage area of the basin to the point of study, in square miles; and

$C_p$  = a coefficient reflecting the peak discharge of the unit hydrograph.

Values of  $C_p$  as a function of  $C_t$  are obtained from Figure 2-5 or by the following equation:

$$C_p = 00.89 C_t^{0.46} \quad (2-9)$$

## Dimensionless Unit Hydrograph

A unit hydrograph is a hydrograph which has been constructed by using observed watershed parameters and storm characteristics to simulate the observed hydrographs of a region. By expressing the coordinates of this hydrograph as ratios of the peak flow and the time to peak a dimensionless hydrograph is derived which can be easily modified by specific basin parameters to represent a unit hydrograph for the watershed.

The shape of the dimensionless unit hydrograph is determined by the following relationship:

$$z = 0.992 C_p T_p/t_p \quad (2-10)$$

where:

z = dimensionless unit hydrograph shape factor.

Once z is calculated for a particular watershed, either Figure 2-6 or Table 2-5 may be used to find w, the dimensionless unit hydrograph family number. The value of w is then adjusted to the nearest value shown in Table 2-6. The  $q/q_p$  ordinates for the adjusted value of w are then read from Table 2-6.

Unit hydrograph ordinates, q, are then calculated for 5-minute intervals of  $T/T_p$  by interpolating between adjacent  $q/q_p$  values and multiplying by  $q_p$ . Another method of calculating q ordinates utilizes the following equation:

$$q = q_p (T/T_p)^w e^{(1 - T/T_p)w}$$

where:

- q = unit hydrograph ordinate, in cfs;
- q<sub>p</sub> = unit hydrograph peak, in cfs;
- T = elapsed time, in minutes or hours;
- T<sub>p</sub> = time to peak, in minutes or hours;
- e = base of natural logarithms, or approximately 2.718; and
- w = dimensionless unit hydrograph family number.

### Design Storm

#### Rainfall Distribution

The design storm for the calculation of runoff hydrographs shall have a duration of 2 hours and a frequency equal to the applicable design criterion. The 10- and 100-year, 2-hour rainfall increments are shown in Table 2-6.

#### Losses

All parts of a basin can be considered either pervious or impervious to the infiltration of rainfall. Impervious areas include buildings, paved streets and lots, and highly compacted soils. As urbanization occurs, the percentage of impervious area, I, increases and causes significant reductions in both infiltration volume and lag time. Correspondingly higher runoff volumes and peak discharges result. Consult Table 2-4 for appropriate values of I for both natural (predevelopment) and ultimate (fully developed) conditions.

Infiltration rates for pervious areas vary depending on storm intensity and duration, soil particle size and compaction, soil cover, and slope. For the CUHP, a uniform infiltration rate of 0.5 inches per hour has been selected as being representative of conditions occurring in the Casper area. It is recommended that the above value be used in the absence of detailed field testing of infiltration rates.

Depression losses accumulate during the initial rainfall period and will continue to some degree throughout the remainder of the storm. Depression storage areas include both natural ponding by swales and vegetation as well as man-made ponding by curbs and buildings. Once the initial loss to depression storage has been satisfied, it continues to occur on impervious surfaces at a rate equal to 5 percent of the rainfall rate. This correction accounts for the fact that even impervious surfaces do not yield 100 percent runoff at peak rainfall intensities. Table 2-8 shows recommended depression storage volumes for various surface types.

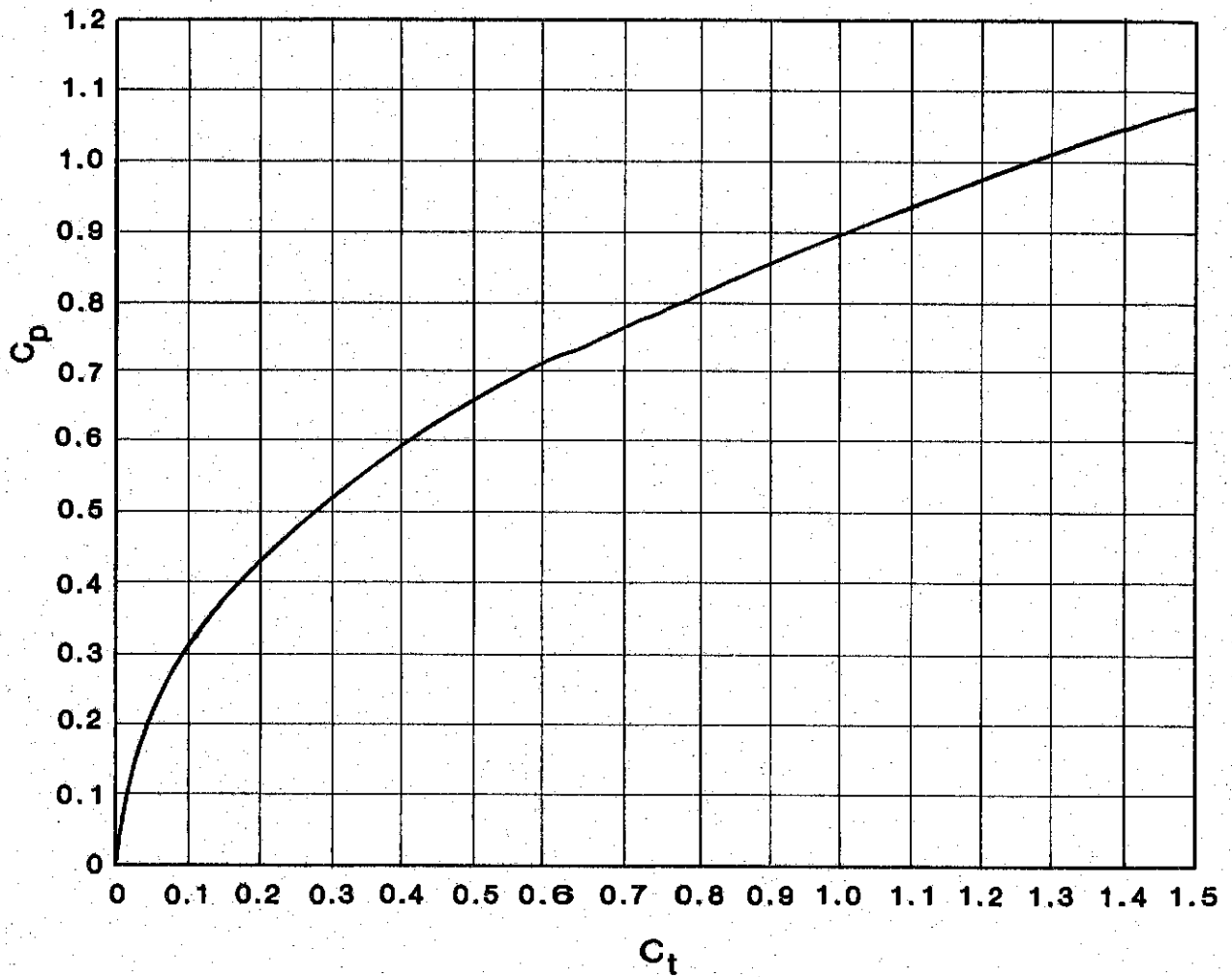

Figure 2-5 Relationship of  $C_t$  to  $C_p$

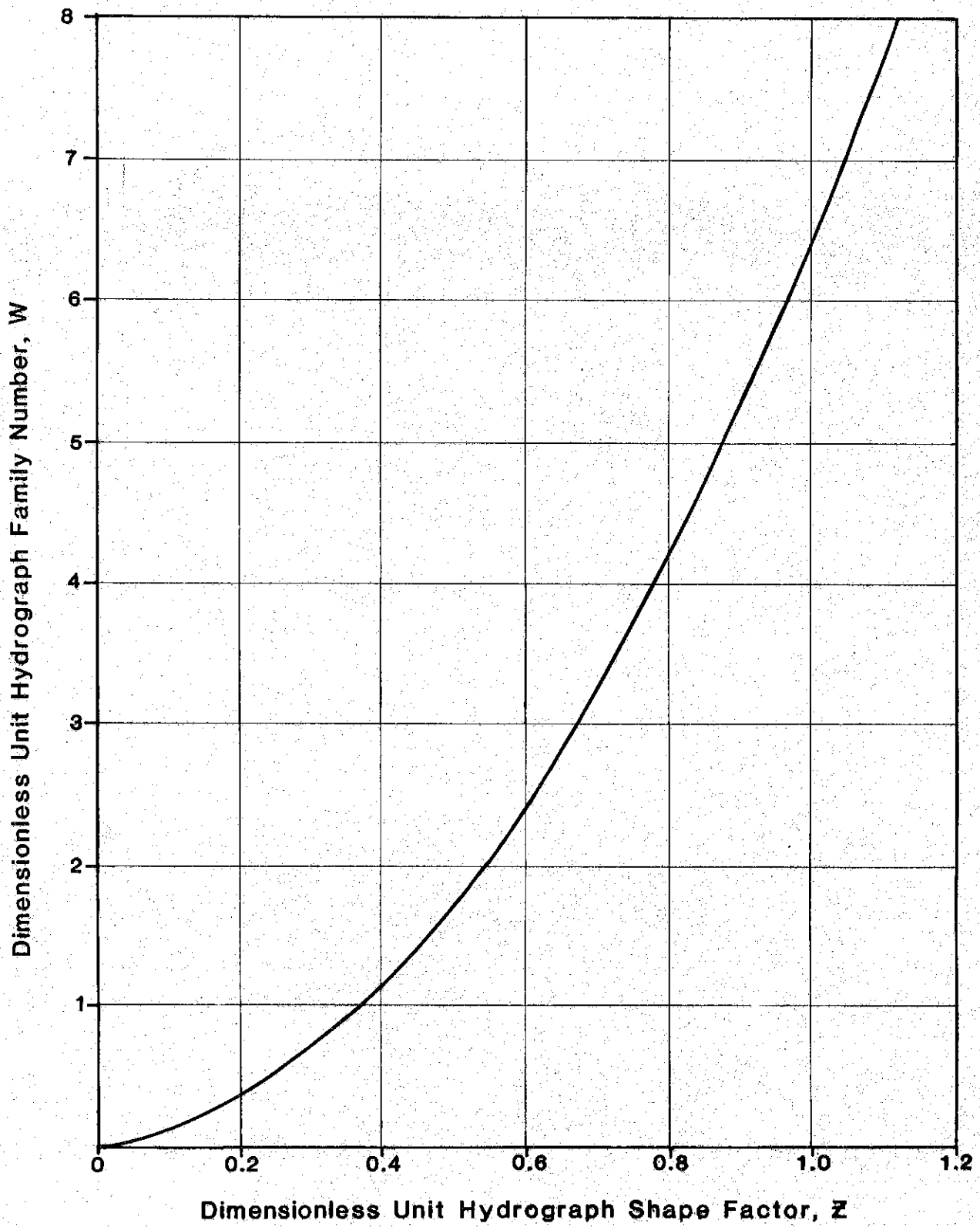

Figure 2-6 Dimensionless Unit Hydrograph Family Number vs. Dimensionless Unit Hydrograph Shape Factor

TABLE 2-5

Dimensionless Unit Hydrograph Family Number vs.  
Dimensionless Unit Hydrograph Shape Factor

<u>Dimensionless Unit Hydrograph Shape Factor, z</u>	<u>Dimensionless Unit Hydrograph Family Number, w</u>
0.368	1.0
0.463	1.5
0.541	2.0
0.610	2.5
0.672	3.0
0.781	4.0
0.877	5.0
0.964	6.0
1.043	7.0
1.117	8.0

TABLE 2-6

## Dimensionless Unit Hydrograph Ordinates

T/T <sub>p</sub>	w									
	1	1.5	2	2.5	3	4	5	6	7	8
	q/q <sub>p</sub>									
0.0	0.00	0.00	0.00	0.00	0.00	0.00	0.00	0.00	0.00	0.00
0.1	.25	.12	.06	.03	.01	.00	.00	.00	.00	.00
0.2	.45	.30	.20	.13	.09	.04	.02	.01	.00	.00
0.3	.60	.47	.36	.28	.22	.13	.08	.05	.03	.02
0.4	.73	.62	.53	.45	.39	.28	.21	.15	.11	.08
0.5	.82	.75	.68	.62	.56	.46	.38	.31	.26	.21
0.6	.90	.85	.80	.76	.72	.64	.57	.51	.46	.41
0.7	.94	.92	.89	.87	.84	.80	.75	.71	.67	.64
0.8	.98	.97	.95	.94	.93	.91	.89	.87	.85	.83
0.9	.99	.99	.99	.99	.98	.98	.97	.96	.96	.96
1.0	1.00	1.00	1.00	1.00	1.00	1.00	1.00	1.00	1.00	1.00
1.1	1.00	.99	.99	.99	.99	.98	.98	.97	.97	.96
1.2	.98	.97	.97	.96	.95	.93	.92	.90	.88	.87
1.3	.96	.95	.93	.91	.89	.86	.83	.80	.77	.74
1.4	.94	.91	.88	.85	.83	.78	.73	.68	.64	.60
1.5	.91	.87	.83	.79	.75	.69	.62	.57	.52	.47
1.6	.88	.82	.77	.72	.68	.59	.52	.46	.40	.35
1.7	.84	.78	.71	.65	.60	.51	.43	.36	.31	.26
1.8	.81	.73	.65	.59	.53	.43	.35	.28	.23	.18
1.9	.77	.68	.60	.52	.46	.36	.28	.21	.16	.13
2.0	.74	.63	.54	.46	.40	.29	.22	.16	.12	.09
2.2	.66	.54	.44	.36	.29	.19	.13	.08	.06	.04
2.4	.59	.46	.35	.27	.21	.12	.07	.04	.03	.02
2.6	.52	.38	.28	.20	.14	.08	.04	.02	.01	.01
2.8	.46	.31	.21	.15	.10	.05	.02	.01	.00	.00
3.0	.41	.26	.16	.11	.07	.03	.01	.00		
3.2	.35	.21	.13	.07	.04	.02	.01			
3.6	.27	.14	.07	.04	.02	.01	.00			
4.0	.20	.09	.04	.02	.01	.00				
4.5	.14	.05	.02	.01	.00					
5.0	.09	.03	.01	.00						
6.0	.04	.01	.00							
7.0	.02	.00								
8.0	.01									
9.0	.00									

TABLE 2-7

Rainfall Increments for the 10- and 100-Year, 2-Hour  
Design Storms

<u>Time (min)</u>	<u>Rainfall Increment (in.)</u>	
	<u>10-yr</u>	<u>100-yr</u>
5	0.01	0.01
10	0.01	0.01
15	0.01	0.01
20	0.01	0.01
25	0.01	0.01
30	0.02	0.02
35	0.03	0.04
40	0.04	0.07
45	0.06	0.10
50	0.08	0.13
55	0.14	0.22
60	0.34	0.53
65	0.18	0.30
70	0.11	0.16
75	0.07	0.11
80	0.05	0.09
85	0.03	0.05
90	0.02	0.04
95	0.01	0.02
100	0.01	0.01
105	0.01	0.01
110	0.01	0.01
115	0.01	0.01
120	0.01	0.01
Total	1.28	1.98



TABLE 2-8

Recommended Depression Storage Volumes  
for Various Land Covers

<u>Land Cover</u>	<u>Depression Storage Volume (in.)</u>
<b>Pervious:</b>	
Lawns	0.3
Wooded Areas and Open Fields	0.4
<b>Impervious:</b>	
Paved Areas	0.1
Roofs (flat)	0.1
Roofs (sloped)	0.05

### Rainfall Excess

Rainfall excess is a function of impervious area, rainfall intensity, infiltration rate, and depression storage volume. A standard procedure as shown in Tables 2-9 shall be followed to compute rainfall excess. The following steps demonstrate the procedure:

1. For the appropriate design frequency, tabulate the rainfall increments in Column 2 using Table 2-7.
2. Tabulate the infiltration rate (not to exceed the rainfall increment rate or 0.04 inches, whichever is less) in Column 3 for pervious areas.
3. Once the rainfall rate in Column 2 exceeds 0.5 inches per hour, satisfy depression storage in Column 4 with the difference between Columns 2 and 3 until the maximum volume from Table 2-8 is reached.
4. Calculate rainfall excess in Column 5 as Column 2 minus Columns 3 and 4.
5. Multiply Column 5 by the fraction of pervious area ( $1-I/100$ ) for the watershed. Tabulate this product in Column 6.
6. For impervious areas, satisfy depression storage at the beginning of the storm in Column 7.
7. Once depression storage is satisfied, enter a value equal to 5 percent of the rainfall increment (Column 2) in Column 8.
8. Calculate rainfall excess in Column 9 as Column 2 minus Columns 7 and 8.
9. Multiply Column 8 by the fraction of impervious area ( $I/100$ ) for the watershed. Tabulate this product in Column 10.

Table 2-9 Determination of Rainfall Excess  
Natural Conditions

Time (min)	Pervious Area (98%)						Impervious Area (2%)				
	Rainfall Increment (in.)	Infiltration (in.)	Depression Storage (in.)	Rainfall Excess (in.)	98 % Rainfall Excess (in.)	Depression Storage (in.)	Other Losses (in.)	Rainfall Excess (in.)	2% Rainfall Excess (in.)	Composite Rainfall Excess (in.)	
(1)	(2)	(3)	(4)	(5)	(6)	(7)	(8)	(9)	(10)	(11)	
5	.01	.01				.01					
10	.01	.01				.01					
15	.01	.01				.01					
20	.01	.01				.01					
25	.01	.01				.01					
30	.02	.02				.02					
35	.03	.03				.03					
40	.04	.04						.04			
45	.06	.04	.02					.06			
50	.08	.04	.04					.08			
55	.14	.04	.10				.01	.13			
60	.34	.04	.24	.06	.06		.02	.32	.01	.07	
65	.18	.04		.14	.14		.01	.17		.14	
70	.11	.04		.07	.07		.01	.10		.07	
75	.07	.04		.03	.03			.07		.03	
80	.05	.04		.01	.01			.05		.01	
85	.03	.03						.03			
90	.02	.02						.02			
95	.01	.01						.01			
100	.01	.01						.01			
105	.01	.01						.01			
110	.01	.01						.01			
115	.01	.01						.01			
120	.01	.01						.01			
<b>Total</b>	<b>1.28</b>	<b>0.57</b>	<b>0.40</b>	<b>0.31</b>	<b>0.31</b>	<b>0.10</b>	<b>0.05</b>	<b>1.13</b>	<b>0.01</b>	<b>0.32</b>	

Table 2-9 Determination of Rainfall Excess  
Ultimate Conditions

Time (min)	Pervious Area (70%)					Impervious Area (30%)					Composite Rainfall Excess (in.) (11)	
	Rainfall Increment (in.) (2)	Infiltration (in.) (3)	Depression Storage (in.) (4)	Rainfall Excess (in.) (5)	70 % Rainfall Excess (in.) (6)	Depression Storage (in.) (7)	Other Losses (in.) (8)	Rainfall Excess (in.) (9)	30% Rainfall Excess (in.) (10)			
5	.01	.01				.01						
10	.01	.01				.01						
15	.01	.01				.01						
20	.01	.01				.01						
25	.01	.01				.01						
30	.02	.02				.02						
35	.03	.03				.03						
40	.04	.04				.04		.04	.01	.01	.01	.01
45	.06	.04	.02			.02		.06	.02	.02	.02	.02
50	.08	.04	.04			.04		.08	.02	.02	.02	.02
55	.14	.04	.10			.10		.13	.04	.04	.04	.04
60	.34	.04	.14	.16	.11	.14		.32	.10	.10	.10	.21
65	.18	.04		.14	.10			.17	.05	.05	.05	.15
70	.11	.04		.07	.05			.10	.03	.03	.03	.08
75	.07	.04		.03	.02			.07	.02	.02	.02	.04
80	.05	.04		.01	.01			.05	.02	.02	.02	.03
85	.03	.03						.03	.01	.01	.01	.01
90	.02	.02						.02	.01	.01	.01	.01
95	.01	.01										
100	.01	.01										
105	.01	.01										
110	.01	.01										
115	.01	.01										
120	.01	.01										
Total	1.28	0.57	0.30	0.41	0.29	0.10	0.05	1.13	0.33	0.33	0.62	

10. Add Columns 6 and 10 and enter the sum in Column 11. This is the composite rainfall excess for each time increment.

### Runoff Hydrograph

Now that both the unit hydrograph and the rainfall excess distribution have been calculated, the runoff hydrograph is calculated. Table 2-10 has been included for the matrix multiplication procedure. Enter the unit hydrograph ordinates in Column 2 and the rainfall excess values across the top of Columns 3 through 26. Successively multiply the ordinates in Column 2 by each rainfall excess values and enter the totals under the appropriate column, shifting the total downward by one time increment with each operation. Finally, add the values in each row and tabulate the runoff hydrograph ordinates in Column 27.

An example using the CUHP is presented using Tables 2-9 and 2-10. Included in the example is Figure 2-7 which displays the unit and runoff hydrographs along with the rainfall excess distributions.

### Example 2

A basin is expected to undergo extensive development from native range to single-family residential land use. It has the following natural condition characteristics:

- A = 200 ac = 0.313 mi<sup>2</sup>
- L = 1.12 mi
- L<sub>c</sub> = 0.67 mi
- S = 0.02 ft/ft
- I = 2%

When fully developed, the basin will have approximately 30 percent impervious area for an average lot size of 10,800 sq ft (Table 2-4). Determine the natural and ultimate 10-year storm hydrographs using CUHP.

1. Determine C<sub>t</sub> given I and S. No adjustment for slope is necessary since  $0.01 \leq S \leq 0.025$  ft/ft. From Figure 2-4:

$$C_t (\text{natural}) = 1.04$$

$$C_t (\text{ultimate}) = 0.54$$

2. Determine  $t_p$  given  $C_t$ ,  $L$ , and  $L_c$ . From Eq. 2-4:

$$t_p = C_t(LL_c)^{0.3}$$

$$t_p \text{ (natural)} = 1.04(1.12 \times 0.67)^{0.3} = 0.954 \text{ hrs}$$

$$t_p \text{ (ultimate)} = 0.54 (1.12 \times 0.67)^{0.3} = 0.495 \text{ hrs}$$

3. Determine  $C_p$  given  $C_t$ . From Eq. 2-9:

$$C_p = 0.89 C_t^{0.46}$$

$$C_p \text{ (natural)} = 0.89(1.04)^{0.46} = 0.91$$

$$C_p \text{ (ultimate)} = 0.89(0.54)^{0.46} = 0.67$$

4. Determine  $q_p$  given  $t_p$ ,  $C_p$ , and  $A$ . From Eq. 2-8:

$$q_p = \frac{640C_pA}{t_p}$$

$$q_p \text{ (natural)} = 640(0.91)(0.313)/0.954 = 191 \text{ cfs}$$

$$q_p \text{ (ultimate)} = 640(0.67)(0.313)/0.495 = 271 \text{ cfs}$$

5. Determine  $T_p$  given  $t_p$ . From Eq. 2-7:

$$T_p = t_p + 0.0417$$

$$T_p \text{ (natural)} = 0.954 + 0.042 = 0.996 \text{ hrs}$$

$$T_p \text{ (ultimate)} = 0.495 + 0.042 = 0.537 \text{ hrs}$$

6. Determine  $z$  given  $C_p$ ,  $T_p$ , and  $t_p$ . From Eq. 2-10:

$$z = 0.992 C_p T_p/t_p$$

$$z \text{ (natural)} = 0.992(0.91)(0.996)/(0.954) = 0.942$$

$$z \text{ (ultimate)} = 0.992(0.67)(0.537)/(0.495) = 0.721$$

7. Determine  $w$  given  $z$ . From Figure 2-6:

$$w \text{ (natural)} = 5.75. \text{ (Use } w = 6.)$$

$$w \text{ (ultimate)} = 3.45. \text{ (Use } w = 3.)$$

8. Compute unit hydrograph ordinates given  $w$ ,  $T_p$ , and  $q_p$ . From Table 2-6:

Table 2-10 Determination of Runoff Hydrograph - Natural Conditions

Time (min) (1)	Unit Hydrograph (cfs) (2)	Rainfall Excess (in.)										Runoff Hydrograph (cfs)														
		(3)	(4)	(5)	(6)	(7)	(8)	(9)	(10)	(11)	(12)	(13)	(14)	(15)	(16)	(17)	(18)	(19)	(20)	(21)	(22)	(23)	(24)	(25)	(26)	(27)
0	0	0																								0
5	0	0	0	0																						0
10	2	0	0	0	0																					0
15	6	0	0	0	0	0																				0
20	15	1	1	0	0	0	0																			2
25	34	2	2	0	0	0	0	0																		4
30	59	4	5	1	0	0	0	0	0																	10
35	94	7	8	2	0	0	0	0	0																	17
40	124	9	13	4	1	0	0	0	0																	27
45	151	11	17	7	2	0	0	0	0																	37
50	174	12	21	9	3	1	1	1	1																	45
55	187	13	24	11	4	1	1	1	1	1																53
60	191	13	26	12	5	1	1	1	1	1	1															57
65	185	13	27	13	5	2	2	2	2	2	2															60
70	176	12	26	13	6	2	2	2	2	2	2															59
75	160	11	25	13	6	2	2	2	2	2	2															57
80	143	10	22	12	6	2	2	2	2	2	2															52
85	126	9	20	11	5	2	2	2	2	2	2															47
90	107	7	18	10	5	2	2	2	2	2	2															42
95	90	6	15	9	4	2	2	2	2	2	2															36
100	74	5	13	7	4	1	1	1	1	1	1															30
105	59	4	10	6	3	1	1	1	1	1	1															24
110	48	3	8	5	3	1	1	1	1	1	1															20
115	38	3	7	4	2	1	1	1	1	1	1															17
120	31	2	5	3	2	1	1	1	1	1	1															13
125	23	2	4	3	1	1	1	1	1	1	1															11
130	17	1	3	2	1	0	0	0	0	0	0															7
135	13	1	2	2	1	0	0	0	0	0	0															6
140	10	1	2	1	1	0	0	0	0	0	0															5
145	8	1	1	1	1	0	0	0	0	0	0															4
150	6	0	1	1	0	0	0	0	0	0	0															2

Table 2-10 Determination of Runoff Hydrograph - Ultimate Conditions

Time (min) (1)	Unit Hydrograph (cfs) (2)	Rainfall Excess (in.)															Runoff Hydrograph (cfs) (27)									
		.01 (3)	.02 (4)	.02 (5)	.04 (6)	.21 (7)	.15 (8)	.08 (9)	.04 (10)	.03 (11)	.01 (12)	.01 (13)	(14)	(15)	(16)	(17)		(18)	(19)	(20)	(21)	(22)	(23)	(24)	(25)	(26)
0	0	0	0	0																						0
5	16	0	0	0																						0
10	65	1	0	0																						1
15	138	1	1	0	0																					2
20	201	2	3	1	1	0																				7
25	247	2	4	3	3	3	0																			15
30	268	3	5	4	6	14	2	0																		34
35	268	3	5	5	8	29	10	1	0																	61
40	252	3	5	5	10	42	21	5	1	0																92
45	225	2	5	5	11	52	30	11	3	0	0															119
50	195	2	5	5	11	56	37	16	6	2	0	0														140
55	160	2	4	5	10	56	40	20	8	4	1	0														150
60	133	1	3	4	9	53	40	21	10	6	1	1														149
65	106	1	3	3	8	47	38	21	11	7	2	1														144
70	84	1	2	3	6	41	34	20	11	8	2	2														130
75	65	1	2	2	5	34	29	18	10	8	3	2														114
80	49	0	1	2	4	28	24	16	9	8	3	3														98
85	35	0	1	1	3	22	20	13	8	7	3	3														81
90	27	0	1	1	3	18	16	11	6	6	2	3														67
95	22	0	1	1	2	14	13	8	5	5	2	2														53
100	16	0	0	1	1	10	10	7	4	4	2	2														41
105	11	0	0	0	1	7	7	5	3	3	1	2														29
110	8	0	0	0	1	6	5	4	3	3	1	1														24
115	5	0	0	0	1	5	4	3	2	2	1	1														19
120	5	0	0	0	0	3	3	2	1	1	1	1														12
125	3	0	0	0	0	2	2	2	1	1	0	1														9
130	3	0	0	0	0	2	2	2	1	1	0	0														7
135	3	0	0	0	0	2	2	2	1	1	0	0														5
140	0	0	0	0	0	1	1	1	1	1	0	0														3
145	0	0	0	0	0	1	1	1	1	1	0	0														2
150	0	0	0	0	0	1	1	1	1	1	0	0														1

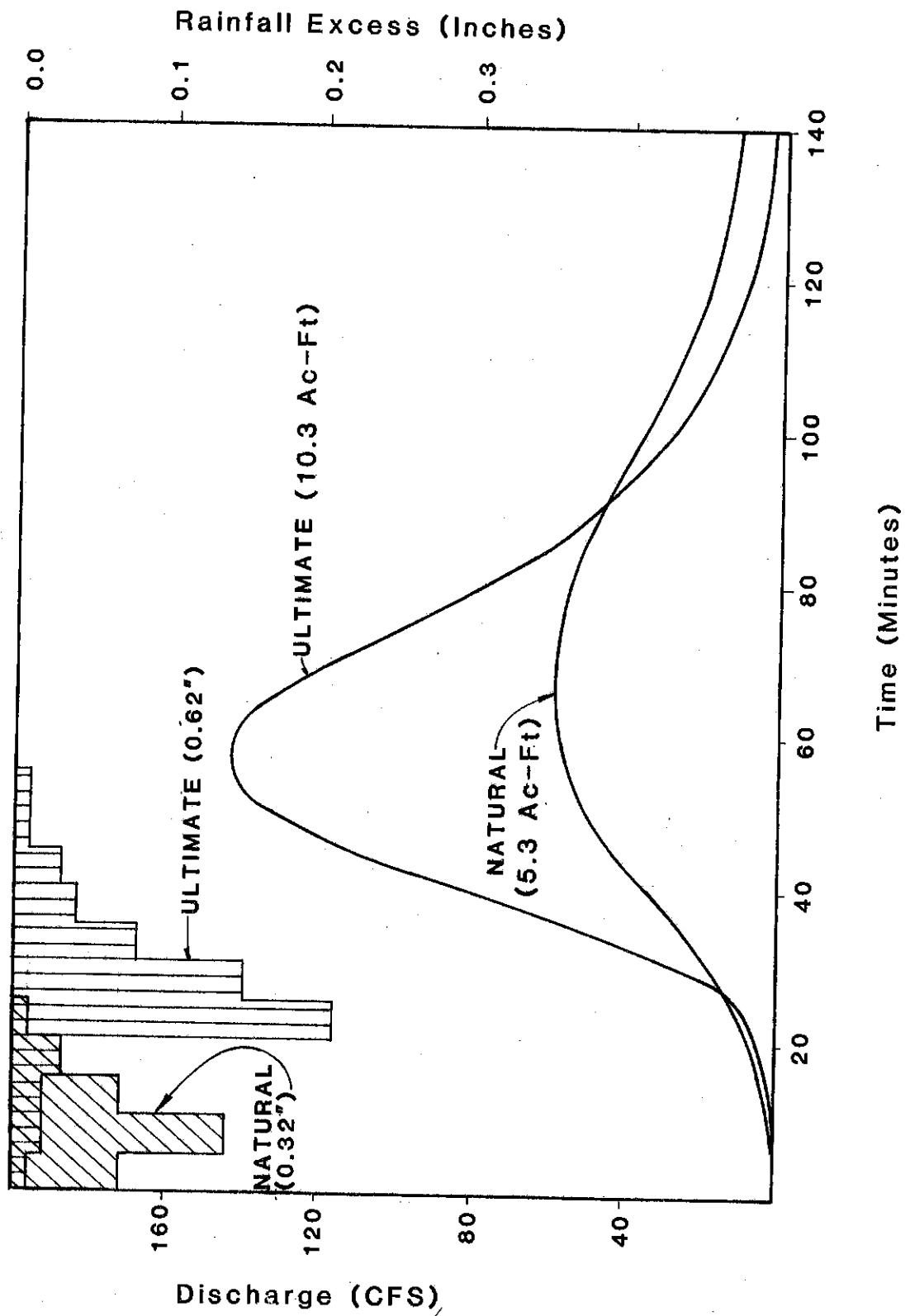

Figure 2-7 Runoff Hydrographs and Rainfall excess distributions for Example 2



T(min)	$T/T_p$ (natural)	$q/q_p(w=6)$	$q$ (natural)	$T/T_p$ (ultimate)	$q/q_p(w=3)$	$q$ (ultimate)
0	0.00	0.00	0	0.00	0.00	0
5	0.08	0.00	0	0.16	0.06	16
10	0.17	0.01	2	0.31	0.24	65
15	0.25	0.03	6	0.47	0.51	138
20	0.33	0.08	15	0.62	0.74	201
25	0.42	0.18	34	0.78	0.91	247
30	0.50	0.31	59	0.93	0.99	268
35	0.59	0.49	94	1.09	0.99	268
40	0.67	0.65	124	1.24	0.93	252
45	0.75	0.79	151	1.40	0.83	225
50	0.84	0.91	174	1.55	0.72	195
55	0.92	0.98	187	1.71	0.59	160
60	1.00	1.00	191	1.86	0.49	133
65	1.09	0.97	185	2.02	0.39	106
70	1.17	0.92	176	2.17	0.31	84
75	1.26	0.84	160	2.33	0.24	65
80	1.34	0.75	143	2.48	0.18	49
85	1.42	0.66	126	2.64	0.13	35
90	1.51	0.56	107	2.79	0.10	27
95	1.59	0.47	90	2.95	0.08	22
100	1.67	0.39	74	3.10	0.06	16
105	1.76	0.31	59	3.26	0.04	11
110	1.84	0.25	48	3.41	0.03	8
115	1.92	0.20	38	3.57	0.02	5
120	2.01	0.16	31	3.72	0.02	5
125	2.09	0.12	23	3.88	0.01	3
130	2.18	0.09	17	4.03	0.01	3
135	2.26	0.07	13	4.19	0.01	3
140	2.34	0.05	10	4.35	0.00	0
145	2.43	0.04	8			
150	2.51	0.03	6			
155	2.59	0.02	4			
160	2.68	0.02	4			
165	2.76	0.01	2			
170	2.84	0.01	2			
175	2.93	0.00	0			

9. Determine the rainfall excess distribution given I using Table 2-9. Assume a predevelopment depression storage volume of 0.4 inches and fully developed values of 0.3 inches for pervious areas and 0.1 inches for impervious areas. Rainfall excess distributions are shown in Figure 2-7 and listed in Table 2-10.
10. Determine the runoff hydrograph ordinates given the unit hydrograph ordinates and the rainfall excess distribution. Runoff hydrographs are shown in Figure 2-7 and listed in Table 2-10.

The example predicts a 94 percent increase in runoff volume (0.62-in. vs. 0.32-in.) and a 150 percent increase in the peak discharge of the runoff hydrograph (150 cfs vs. 60 cfs) as a result of urban development within the basin.

### 2.30 Bibliography

1. American Society of Civil Engineers, Design and Construction of Sanitary and Storm Sewers, Manuals and Reports on Engineering Practice, No. 37, New York, NY, 1969.
2. Aron, G. and E.L. White, Fitting a Gamma Distribution Over a Synthetic Unit Hydrograph, American Water Resources Association, Water Resources Bulletin, Vol. 18, No. 1, Minneapolis, MN, 1982.
3. Craig, G.S. and J.G. Rankl, Analysis of Runoff from Small Drainage Basins in Wyoming, U.S. Geological Survey Water-Supply Paper 2056, Washington, DC, 1978.
4. Federal Highway Administration, Design of Urban Highway Drainage - The State of the Art, Washington, D.C., 1979.
5. Henningson, Durham & Richardson, Inc., Omaha Metropolitan Area Stormwater Management Design Manual, City of Omaha, Douglas County, and Pappo Natural Resources District, Omaha, NE, 1980.
6. Miller, J.F., R.H. Frederick, and R.J. Tracey, Precipitation - Frequency Atlas of the Western United States, NOAA Atlas 2, Vol. II - Wyoming, U.S. Weather Service, Washington, DC, 1973.
7. Resource Consultants, Inc., Larimer County Stormwater Management Manual, Fort Collins, CO, 1979.
8. Soil Conservation Service, National Engineering Handbook, Section 4, Hydrology, Washington, DC, 1971.
9. Wright-McLaughlin Engineers, Urban Storm Drainage Criteria Manual, Vol 1, Denver Regional Council of Governments, Denver, CO, 1977.

C

C

C

Table 2-9 Determination of Rainfall Excess

Time (min)	Pervious Area (%)					Impervious Area (%)					Composite Rainfall Excess (in.) (11)	
	Rainfall Increment (in.) (2)	Infiltration (in.) (3)	Depression Storage (in.) (4)	Rainfall Excess (in.) (5)	% Rainfall Excess (in) (6)	Depression Storage (in.) (7)	Other Losses (in.) (8)	Rainfall Excess (in.) (9)	% Rainfall Excess (in.) (10)			
(1)												
5												
10												
15												
20												
25												
30												
35												
40												
45												
50												
55												
60												
65												
70												
75												
80												
85												
90												
95												
100												
105												
110												
115												
120												
Total												

Table 2-10 Determination of Runoff Hydrograph

Time (min) (1)	Rainfall Excess (in.)															Runoff Hydrograph (cfs) (27)											
	(2)	(3)	(4)	(5)	(6)	(7)	(8)	(9)	(10)	(11)	(12)	(13)	(14)	(15)	(16)		(17)	(18)	(19)	(20)	(21)	(22)	(23)	(24)	(25)	(26)	
0																											
5																											
10																											
15																											
20																											
25																											
30																											
35																											
40																											
45																											
50																											
55																											
60																											
65																											
70																											
75																											
80																											
85																											
90																											
95																											
100																											
105																											
110																											
115																											
120																											
125																											
130																											
135																											
140																											
145																											
150																											

### Section 3

#### Street Drainage

- 3.10 Effects of Stormwater on Street Capacity
  - Interference Due to Sheet Flow Across Pavement
  - Hydroplaning
  - Splash
  - Interference Due to Gutter Flow
  - Interference Due to Ponding
  - Interference Due to Water Flowing Across Traffic Lane
  - Effect on Pedestrians
- 3.20 Design Criteria
  - Street Capacity for Initial Storms
  - Calculating Theoretical Capacity
  - Street Capacity for Major Storm
  - Calculating Theoretical Capacity
  - Ponding
  - Cross-Street Flow
- 3.30 Intersection Layout Criteria
  - Gutter Capacity, Initial Storm
  - Gutter Capacity, Major Storm
  - Ponding
  - Cross-Street Flow
- 3.40 Bibliography

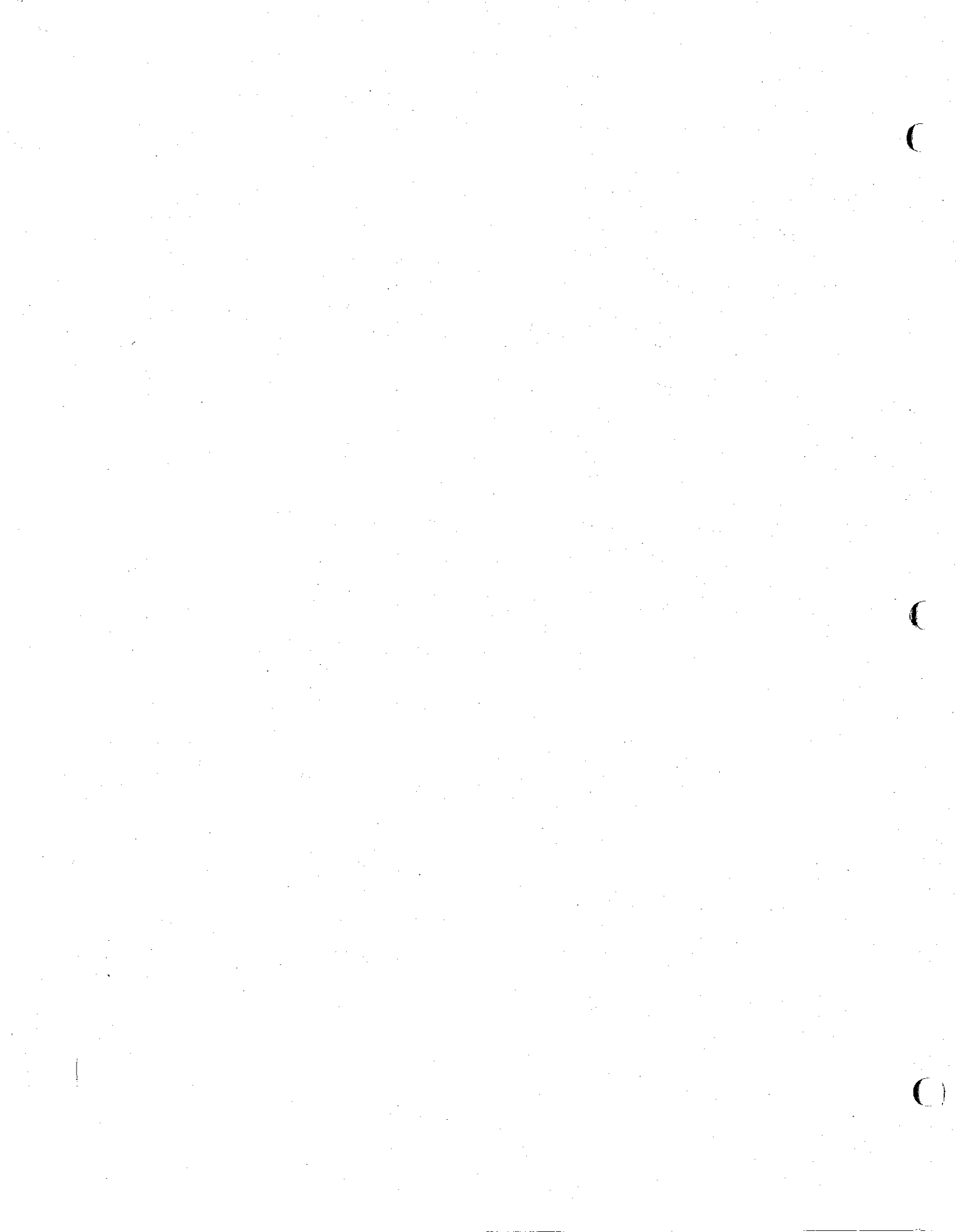

## Section 3

### Street Drainage

Streets serve an important and necessary drainage service even though their primary function is for the movement of traffic. Traffic and drainage uses are compatible up to a point, beyond which drainage must be subservient to traffic needs.

Gutter flow in streets is necessary to transport runoff to storm inlets and to major drainage channels. Good planning of streets can substantially help in reducing the size of, and sometimes eliminating the need for, a storm sewer system in newly urbanized areas.

Definition of Symbols for Sections 3 and 4 are found in Section 4.8.

#### 3.10 Effects of Stormwater on Street Capacity

The storm runoff which influences the traffic capacity of a street can be classified as follows.

- A. Sheet flow across the pavement as falling rain flows to the edge of the pavement.
- B. Runoff flowing adjacent to the curb.
- C. Stormwater ponded at low points.
- D. Flow across the traffic lane from external sources, or cross-street flow (as distinguished from water falling on the pavement surface).
- E. Splashing of any of the above types of flow on pedestrians.

Each of these types of storm runoff must be controlled within acceptable limits so that the street's main function as a traffic carrier will not be unduly restricted.

The effect of each of the above categories of runoff on traffic movement are discussed in the following sections.

#### Interference Due to Sheet Flow Across Pavement

Rainfall which falls upon the paved surface of a street or road must flow overland as sheet flow until it reaches a channel. Channels can be created either by curbs and gutters or by roadside ditches. The direction of flow on the street may be determined by the vector addition of the street grade and the crown slope, which is equivalent to drawing the perpendicular to a contour line on the road as shown in Figure 3-1. The depth of sheet flow will be essentially zero at the crown of the street and will increase as it proceeds towards the channel. Traffic interference due to sheet flow is essentially of two types: hydroplaning and splash.



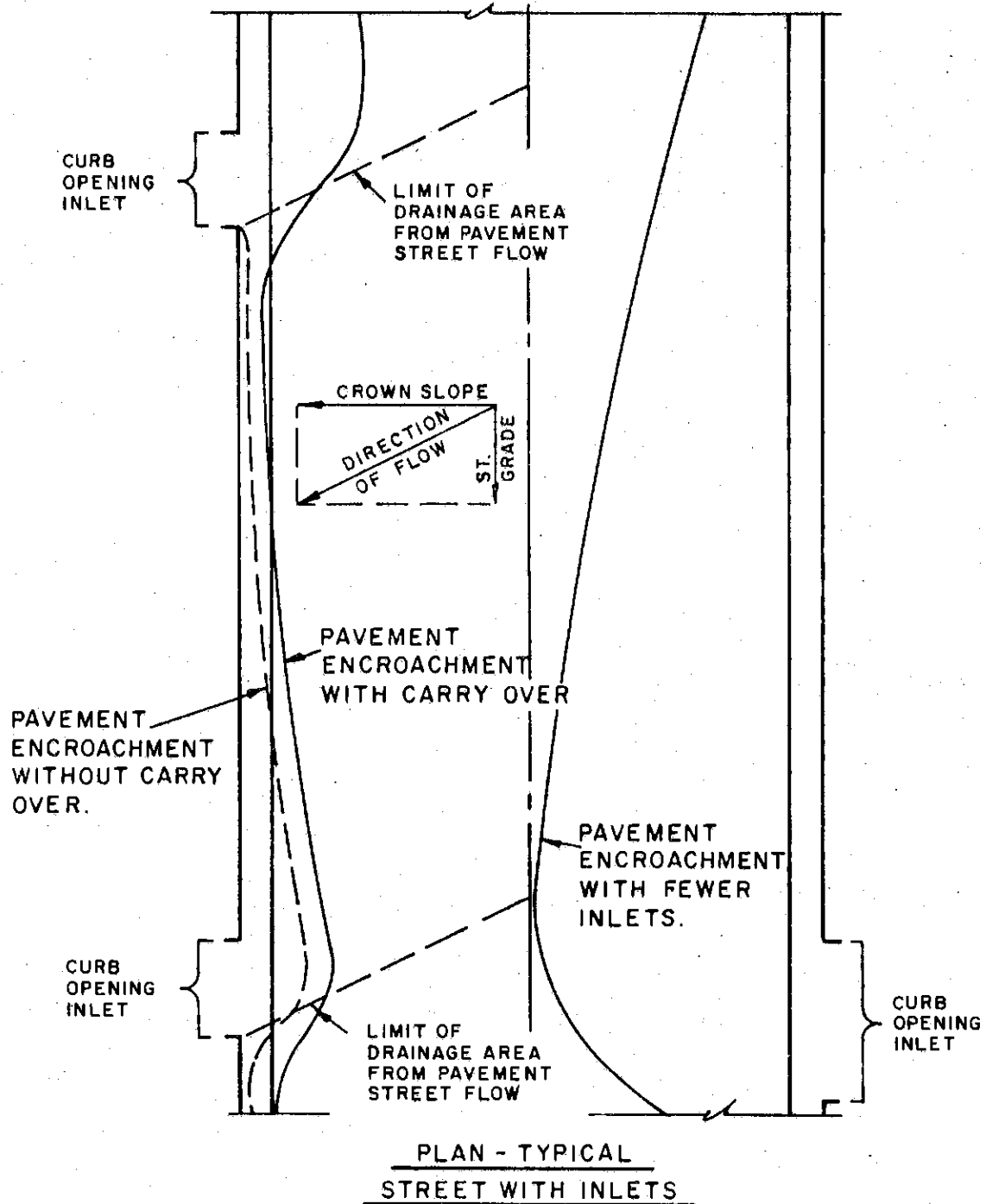

Figure 3-1 Gutter and Pavement Flow Patterns

## Hydroplaning

Hydroplaning is the phenomenon of vehicle tires actually being supported by a film of water which acts as a lubricant between the pavement and the vehicle. It generally occurs at speeds commensurate with freeways or arterial streets and its effect can be minimized by achieving a relatively rough pavement which will allow water to escape from beneath the tires by pavement grooving to provide drainage, or by reducing travel speed.

## Splash

Traffic interference due to splash results from sheet flow of excessive depth caused by water traveling a long distance or at a very low velocity before reaching a gutter. Increasing the street crown slope will decrease both the time and distance required for water to reach the gutter. The crown slope, however, must be kept within acceptable limits to prevent side-slipping of traffic during frozen surface conditions and to allow the opening of doors when parked adjacent to curbs. An exceedingly wide pavement section contributing flow to one curb will also affect the depth of sheet flow. This may be due to superelevation of a curve, off-setting of the street crown due to warping of curbs at intersections, or many traffic lanes between street crown and the gutter. Consideration should be given to all of these factors to maintain a depth of sheet flow within acceptable limits.

## Interference Due to Gutter Flow

Water which enters a street, either sheet flow from the pavement surface or overland flow from adjacent land areas, will flow in the gutter of the street until it reaches an outlet, such as a storm sewer or a channel. Figure 3-1 shows the configuration of gutter flow moving down a street when there is a storm sewer system. As the flow progresses downhill and additional areas contribute to the runoff, the width of flow will increase and progressively infringe upon the traffic lane. If vehicles are parked adjacent to the curb, the width of spread will have little influence on traffic until it exceeds the width of the vehicle by several feet. However, on streets where parking is not permitted, as with many arterial streets, whenever the flow width exceeds a few feet it will significantly affect traffic. Field observations show that vehicles will crowd adjacent lanes to avoid curb flow.

As the width increases it becomes impossible for vehicles to operate without driving through water, and they again begin to use the inundated lane. At this point the traffic velocity will be significantly reduced as the vehicles begin to drive through the deeper water. Splash from vehicles traveling in the inundated lane obscures the vision of drivers of vehicles moving at a higher rate of speed on the open lane.

Eventually, if width and depth of flow become great enough, the street will become ineffective as a traffic carrier. During these periods it is imperative that emergency vehicles such as fire trucks, ambulances, and police cars be able to traverse the street by moving along the crown of the roadway.

The street classification is also important when considering the degree of interference to traffic. A local street, and to a lesser extent a collector street, could be inundated with little effect upon vehicular travel. The small number of cars involved could move at a low rate of speed through the water even if the depth were four to six inches. However, reducing the speed of freeway or arterial traffic affects a great number of private, commercial, and emergency vehicles.

#### **Interference Due to Ponding**

Storm runoff ponded on the street surface because of a change in grade or the crown slope of intersecting streets has a substantial effect on traffic. A major problem with ponding is that it may reach depths greater than the curb and remain on the street for long periods of time. Another problem is that ponding is localized in nature and vehicles may enter a pond moving at a high rate of speed.

The manner in which ponded water affects traffic is essentially the same as for curb flow; the width of spread onto the traffic lane is the critical parameter. Ponded water will often bring traffic on a street to a complete halt. In this case, incorrect design of only one facet of an entire street and storm drainage system will render the remainder of the street system useless during the runoff period.

#### **Interference Due To Water Flowing Across Traffic Lane**

Whenever storm runoff, other than sheet flow, moves across a traffic lane, a serious impediment to traffic flow occurs. The cross flow may be caused by superelevation of a curve or a street intersection exceeding the capacity of the higher gutter on a street with cross fall. The problem associated with this type of flow is the same as for ponding in that it is localized in nature and vehicles may be traveling at high speed when they reach the location. If the velocity of vehicles is naturally slow and use is light, such as on local streets, cross-street flow does not cause sufficient interference to be objectionable.

The depth and velocity of cross-street flow should always be maintained within such limits that it will not have sufficient force to affect moving traffic. If a vehicle which is hydroplaning enters an area of cross street flow, even a minor force could be sufficient to move it laterally towards the gutter.

At certain intersections the flow may be trapped between converging streets and must either flow over one street or be carried underground. If the vehicles crossing the intersection are required to stop, then very little hazard exists to the traveling public. This is the basis for the assumption that crossspans are acceptable across a local street where it intersects another local or collector street. Another point in favor of the use of crossspans is the continuation of the grade of the dominant street. If the crown of the local street is allowed to coincide with the crown of the major street, the outside traffic lanes of the major street will have a "hump" at the intersection.

## Effect on Pedestrians

In areas where pedestrians frequently use sidewalks, splash due to vehicles moving through water adjacent to the curb is a serious problem having adverse sociological impact. It must also be kept in mind that under certain circumstances, pedestrians will be required to cross ponded water adjacent to curbs.

Since the majority of pedestrian traffic will cease during the actual rainstorm, less consideration need be given to the problem while the rain is actually falling. Ponded water, however, remaining after the storm has passed, must be negotiated by pedestrians.

Streets should be classified with respect to pedestrian traffic as well as vehicular traffic. As an example, streets which are classified as local for vehicles and located adjacent to a school are arterials for pedestrian traffic. Allowable width of gutter flow and ponding should reflect this fact.

### 3.20 Design Criteria

Design criteria for the collection and transport of runoff on public streets is based on a reasonable frequency of traffic interference. That is, depending on the character of the street, certain traffic lanes can be fully inundated once during the initial design storm return period, usually once each 10 years. However, during this period lesser storms occur which will produce runoff and inundate traffic lanes to some smaller degree.

Planning and design for urban storm runoff must be considered from the viewpoint of both the regularly expected storm occurrence, that is, the initial storm, and the major storm occurrence. The initial storm will have a frequency of one in 10 years. The major storm will have a return period of 100 years. The objectives of the major storm runoff planning and design is to eliminate major damage and loss of life. The initial drainage system is necessary to eliminate inconvenience, frequently recurring minor damage, and high street maintenance costs.

### Street Capacity for Initial Storms

Determination of street capacity for the initial storm shall be based upon two considerations:

- A. Pavement encroachment for computed theoretical flow conditions.
- B. An empirical reduction of the theoretical allowable rate of flow to account for practical field conditions.

### Pavement Encroachment

The pavement encroachment for the initial storm shall be limited as set forth in the following Table.

TABLE 3-1

Allowable Initial Storm Runoff Encroachment

<u>Street Classification</u>	<u>Initial Storm Frequency</u>	<u>Maximum Encroachment</u>
Local	10-year	No curb over-topping.* Flow may cover crown of street.
Collector	10-year	No curb over-topping.* Flow spread must leave at least one lane (12 ft) free of water for a two lane roadway and two lanes for a four lane roadway.
Arterial	10-year	No curb over-topping.* Flow spread must leave at least one lane free of water in each direction.
Expressway	10-year**	No encroachment is allowed on any traffic lane.

\* Where no curbing exists, encroachment shall not extend over property lines except at drainage easements.

\*\* 50-year for a depressed highway cross section.

The storm sewer system should commence at the point where the maximum encroachment is reached, and should be designed on the basis of the initial storm. Development of the major drainage system is encouraged so that the initial runoff is removed from the streets, thus moving the point at which the storm sewer system must begin further downstream.

Calculating Theoretical Capacity

When the allowable pavement encroachment has been determined, the theoretical gutter capacity for a particular encroachment shall be computed using the modified Manning's Formula for flow in shallow triangular channels, as shown on Figure 3-2.

Figure 3-2, Nomograph for Flow in Triangular Gutters, may be utilized for all gutter configurations. To simplify computations, graphs for particular street shapes may be plotted. An "n" value of 0.016 shall be utilized for a concrete curb and gutter unless special considerations exist.

Allowable Gutter Flow

The actual flow rate allowable per gutter shall be calculated by multiplying the theoretical capacity by the corresponding factor obtained from Figure 3-3. The designer will then be able to develop discharge curves for standard streets. This adjustment allows for flow obstructions due to debris and parked vehicles along the curb.

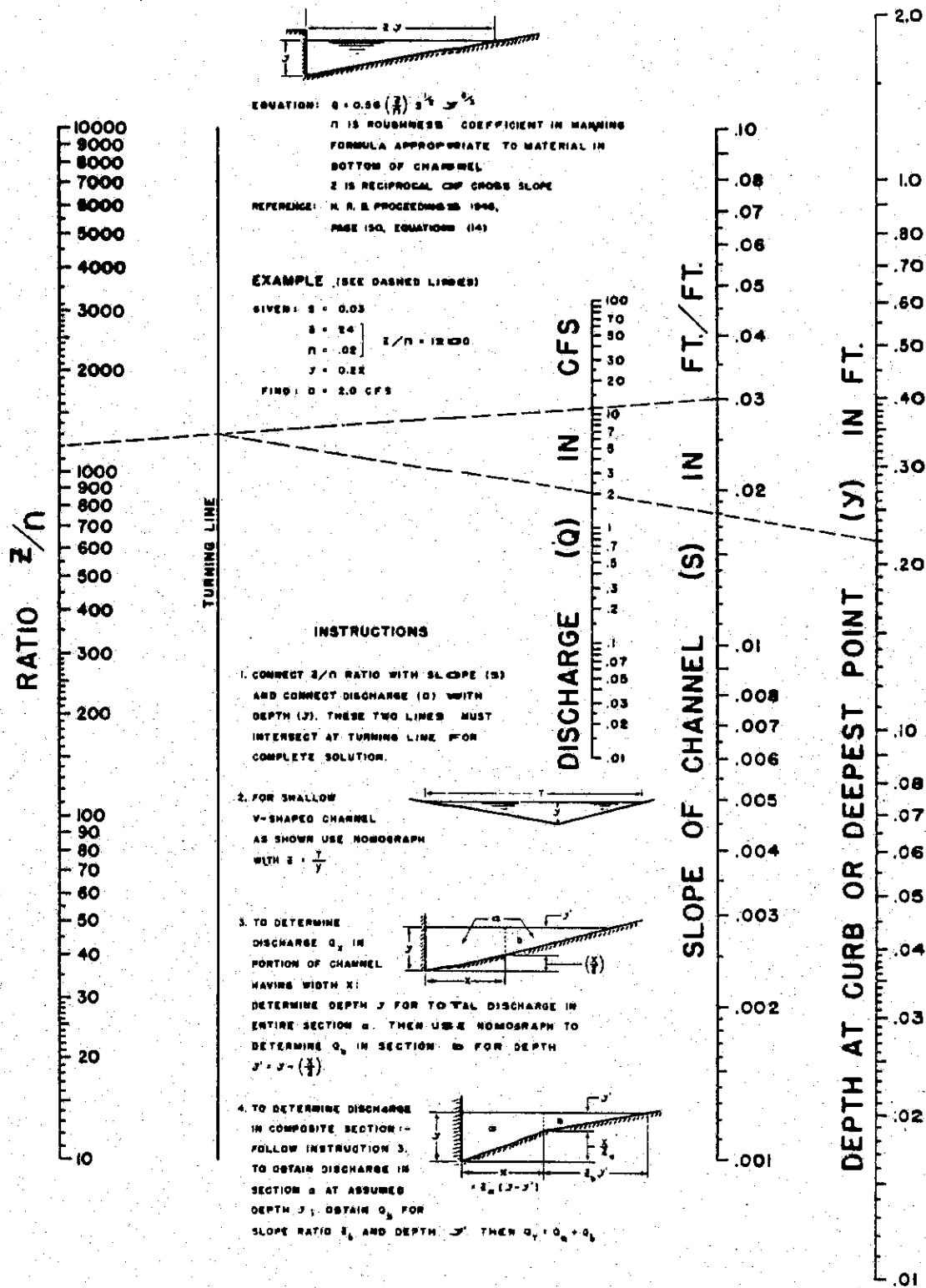
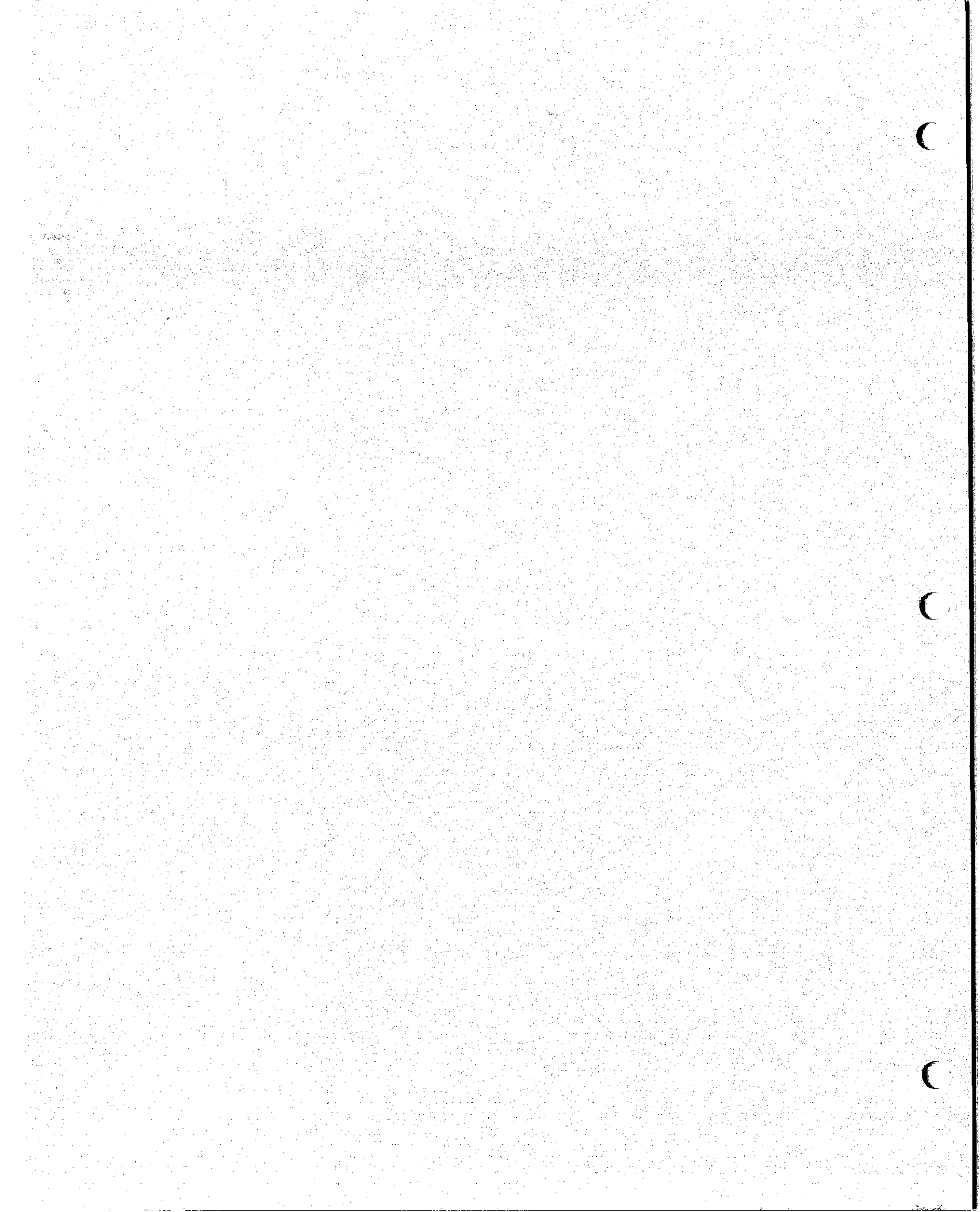

Figure 3-2 Nomograph for Flow in Triangular Gutters



### Example

#### Gutter Carrying Capacity, Initial Storm

Given: 6" vertical curb  
2'-wide by 2"-deep gutter  
2% pavement crown slope  
36' street width, curb to curb  
Crown offset to 1/4 point for cross fall = 0.36 ft  
Collector street  
Street grade = 5%

Find: Allowable capacity, each gutter.

1. Determine allowable pavement encroachment.

From Table 3-1, one lane must remain open.

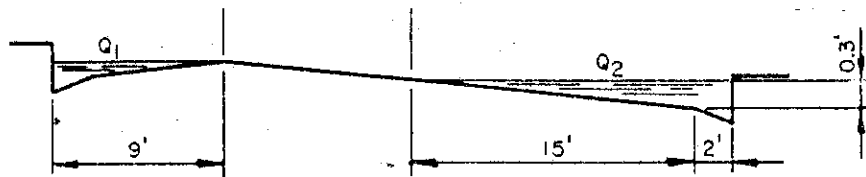

2. Calculate theoretical capacity for each gutter.

Using Nomograph, Figure 3-2.

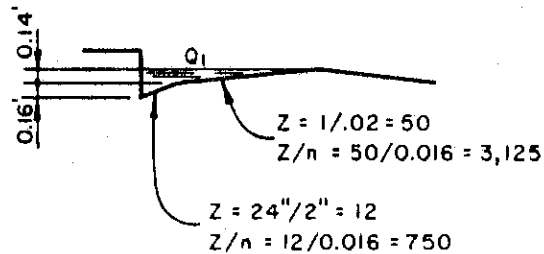



$$Q_1 = 3.7 \text{ cfs} - 0.5 \text{ cfs} + 2.0 \text{ cfs} = 5.2 \text{ cfs}$$

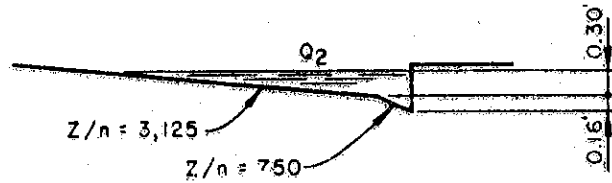

$$Q_2 = 10 \text{ cfs} - 3.8 \text{ cfs} + 15 \text{ cfs} = 21.2 \text{ cfs}$$

3. Calculate allowable gutter capacity.

From Figure 3-3, for 5% slope, factor = 0.49

$$Q_1 = 5.2 \text{ cfs} \times 0.49 = 2.5 \text{ cfs}$$

$$Q_2 = 21.2 \text{ cfs} \times 0.49 = 10.4 \text{ cfs}$$

**Street Capacity for Major Storm**

Determination of the allowable flow for the major storm shall be based upon two considerations:

- A. Theoretical capacity based upon allowable depth and inundated area.
- B. Reduced allowable flow due to velocity considerations.

**Allowable Depth and Inundated Area**

The allowable depth and inundated area for the major storm shall be limited as set forth in Table 3-2.

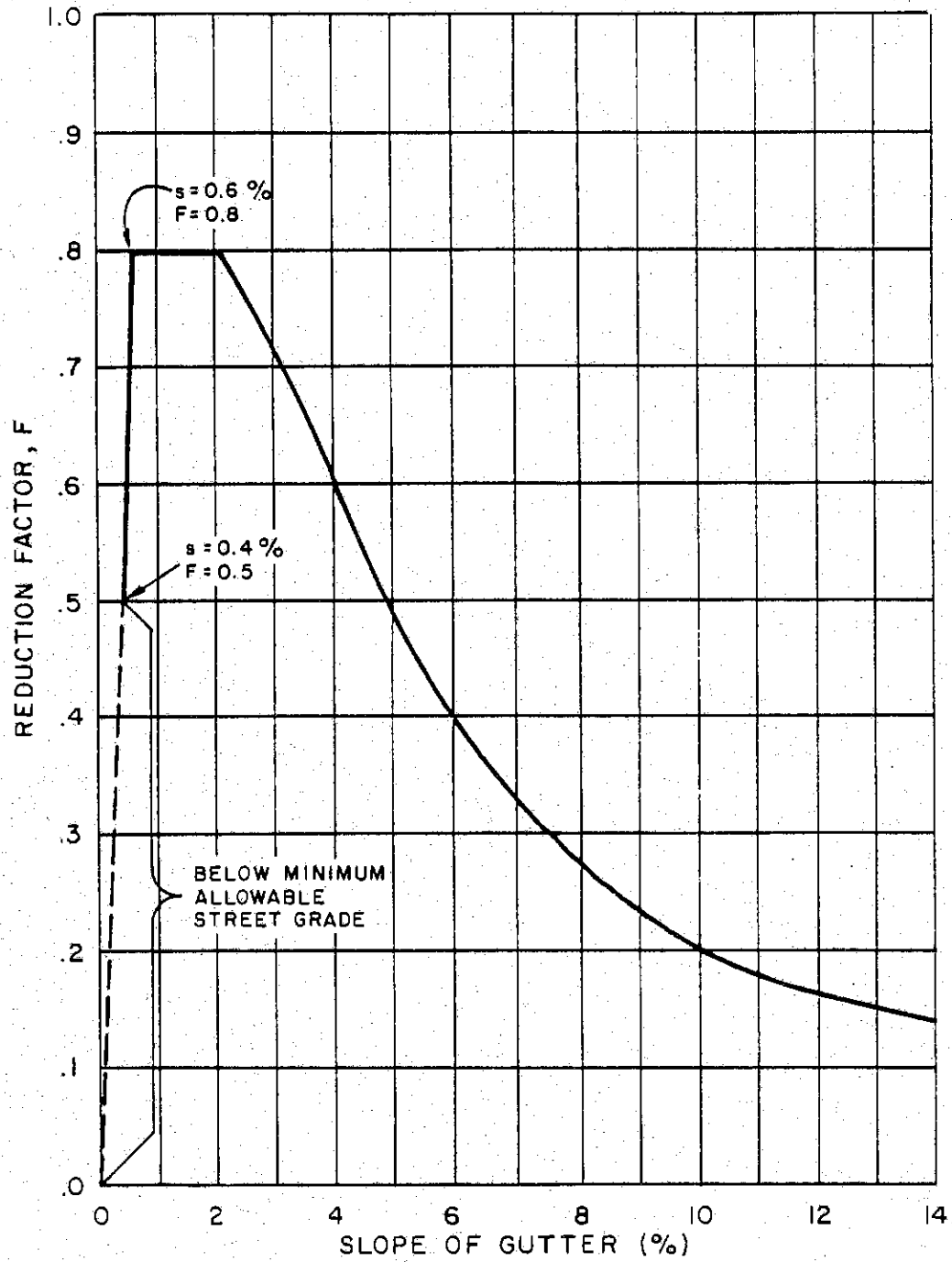

APPLY REDUCTION FACTOR FOR APPLICABLE SLOPE TO THE THEORETICAL GUTTER CAPACITY TO OBTAIN ALLOWABLE GUTTER CAPACITY.

Figure 3-3 Reduction Factors for Allowable Gutter Capacity

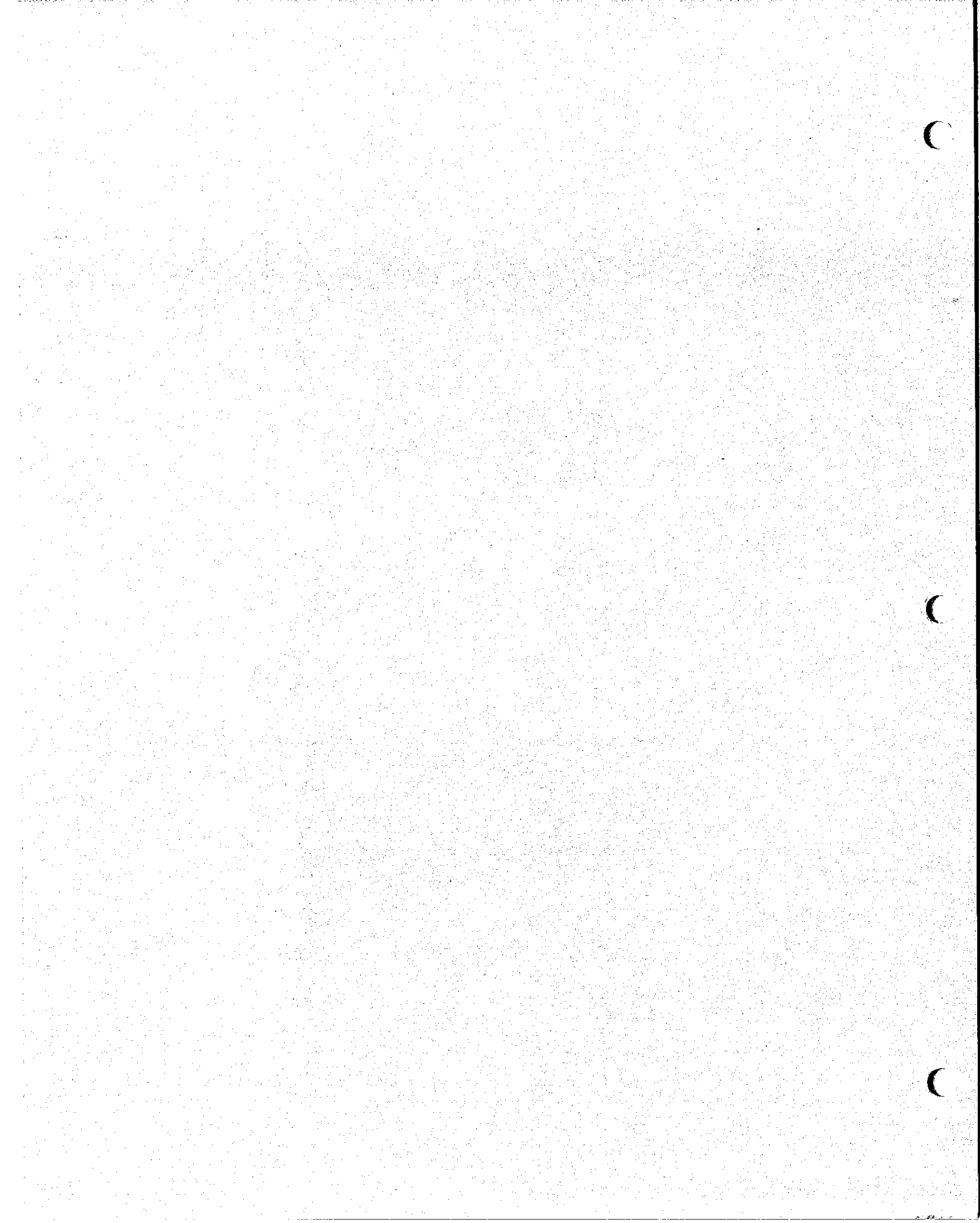

## Calculating Theoretical Capacity

Based upon the allowable depth and inundated area as determined from Table 3-2, the theoretical street capacity shall be calculated. Manning's Formula shall be utilized with an "n" value applicable to the actual boundary conditions encountered. See Table 7-2 for alternate values of n.

### Allowable Flow for Major Storm

The actual flow allowable within the street right-of-way shall be calculated by multiplying the theoretical capacity by the corresponding factor obtained from Figure 3-3.

TABLE 3-2

### Allowable Major Storm Runoff Inundation

<u>Street Classification</u>	<u>Allowable Depth and Inundated Areas</u>
Local and Collector	Residential dwellings, public, commercial, and industrial buildings, shall not be inundated at the ground line, unless buildings are flood-proofed. The depth of water over the gutter flowline shall not exceed 18 inches.
Arterial and Freeway	Residential dwellings, public, commercial, and industrial buildings, shall not be inundated at the ground line, unless buildings are flood-proofed. Depth of water at the street crown shall not exceed 6 inches to allow operation of emergency vehicles. The depth of water over the gutter flowline shall not exceed 18 inches.

### Ponding

The term ponding shall refer to areas where runoff is restricted to the street surface by sump inlets, street intersections, low points, intersections with drainage channels, or other reasons.

### Initial Storm

Limitations for pavement encroachment by ponding for the initial storm shall be those presented in Table 3-1, Allowable Use of Streets for Initial Storm Runoff. These limitations shall determine the allowable depth at inlets, gutter turnouts, culvert headwaters, etc.

### Major Storm

Limitations for depth and inundated area for Major Storms shall be those presented in Table 3-2, Major Storm Runoff Allowable Street Inundation.

These limitations shall determine the allowable depth at inlets, gutter turnouts, culvert headwaters, etc.

### Cross-Street Flow

Cross-street flow is classified into two general categories. The first type is runoff which has been flowing in a gutter and then flows across the street to the opposite gutter or to an inlet. The second type is flow from some external source, such as a drainage way, which will flow across the crown of a street when the conduit capacity beneath the street is exceeded.

### Depth

Cross-street flow depth shall be limited as set forth in Table 3-3.

TABLE 3-3

#### Allowable Cross-Street Flow

<u>Street Classification</u>	<u>Initial Design Runoff</u>	<u>Major Design Runoff</u>
Local	6-inch depth at crown	18 inches of depth above gutter flowline
Collector	Where cross pans are allowed, depth of flow shall not exceed 6 inches.	18 inches of depth above gutter flowline
Arterial	None	6 inches or less over crown
Freeway	None	6 inches or less over crown

### Theoretical Capacity

Based upon the limitations in Table 3-3 and other applicable limitations (such as ponding depth), the theoretical quantity of cross-street flow shall be calculated. Where allowable ponding depth would cause cross-street flow, the limitation shall be the minimum allowable of the two criteria.

### Allowable Quantity

Once the theoretical cross-street capacity has been computed, the allowable quantity shall be calculated by multiplying the theoretical capacity by the corresponding factor from Figure 3-3. The slope of the pavement downstream of the street crown shall be used in lieu of the gutter slope.

### 3.30 Intersection Layout Criteria

The following design criteria are applicable at intersections of urban streets. Gutter capacity limitations covered above shall apply along the street, while this section shall govern at the intersection.

## Gutter Capacity, Initial Storm

### Pavement Encroachment

Limitations at intersections for pavement encroachment shall be as given in Table 3-1, Allowable Use of Streets for Initial Storm Runoff.

### Theoretical Capacity

The theoretical capacity of each gutter approaching an intersection shall be calculated based upon the most critical cross section.

- a. **Continuous Grade Across Intersection.**  
When the gutter flow will be continued across an intersection, the slope used for calculating capacity shall be that of the gutter flow line crossing the street. (Figure 3-4, Intersection Drainage Design Considerations)
- b. **Flow Direction Change at Intersection.**  
When the gutter flow must undergo a direction change at the intersection greater than 45 degrees, the slope used for calculating capacity shall be the effective gutter slope, defined as the average of the gutter slopes at 0 ft, 25 ft, and 50 ft from the point of direction change (Figure 3-4, Intersection Drainage).
- c. **Flow Interception by Inlet.**  
When gutter flow will be intercepted by an inlet on continuous grade at the intersection, the effective gutter slope shall be utilized for calculations. Under this condition, the points for averaging shall be 0 ft, 25 ft, and 50 ft upstream from the inlet (Figure 3-4, Intersection Drainage Design Considerations).

### Allowable Capacity

The allowable capacity for gutters approaching an intersection shall be calculated by applying a reduction factor to the theoretical capacity as covered in the following sections.

- a. **Flow Approaching an Arterial Street.**  
When the direction of flow is towards an arterial street, the allowable carrying capacity shall be calculated by applying the reduction factor from Figure 3-5 to the theoretical gutter capacity. The grade used to determine the reduction factor shall be the same effective grade used to calculate the theoretical capacity.
- b. **Flow Approaching Streets other than Arterial.**  
When the direction of flow is towards a non-arterial street, the allowable carrying capacity shall be calculated by applying the reduction factor from Figure 3-3 to the

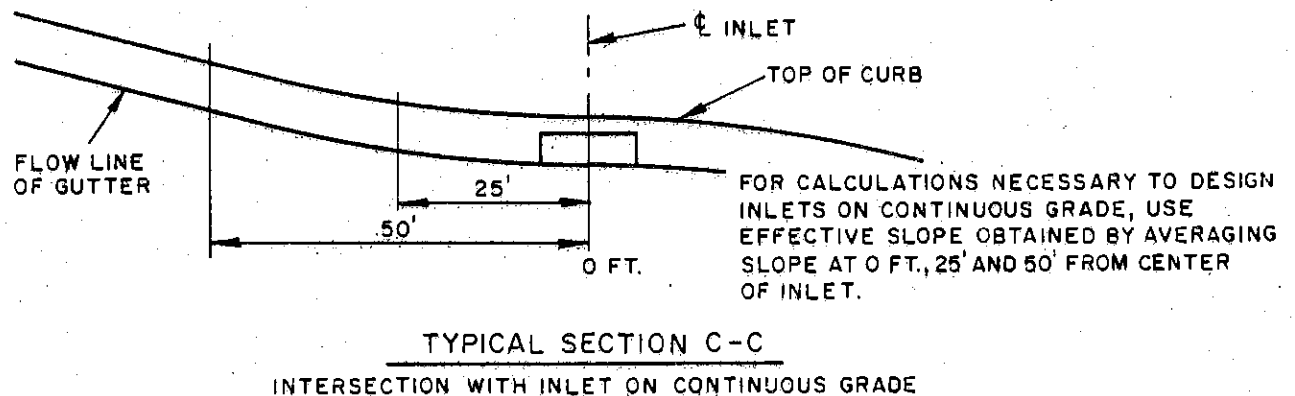
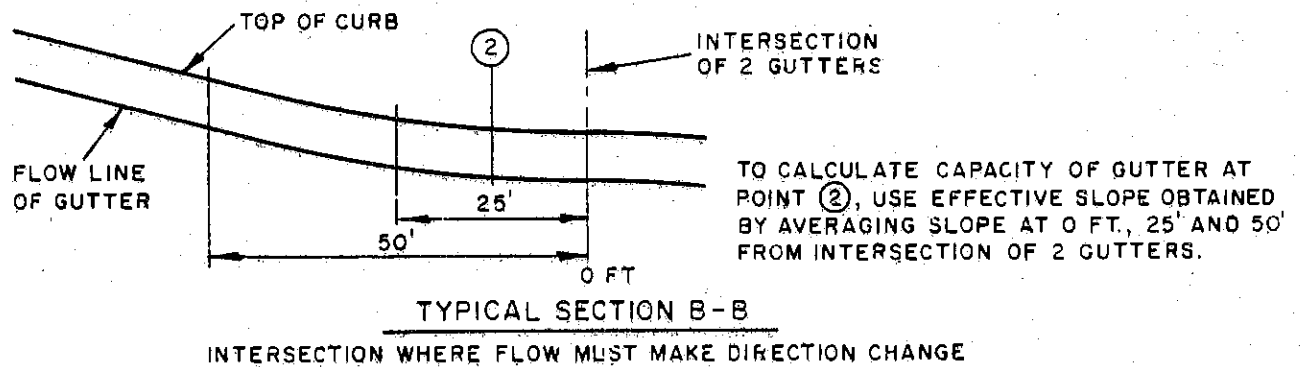
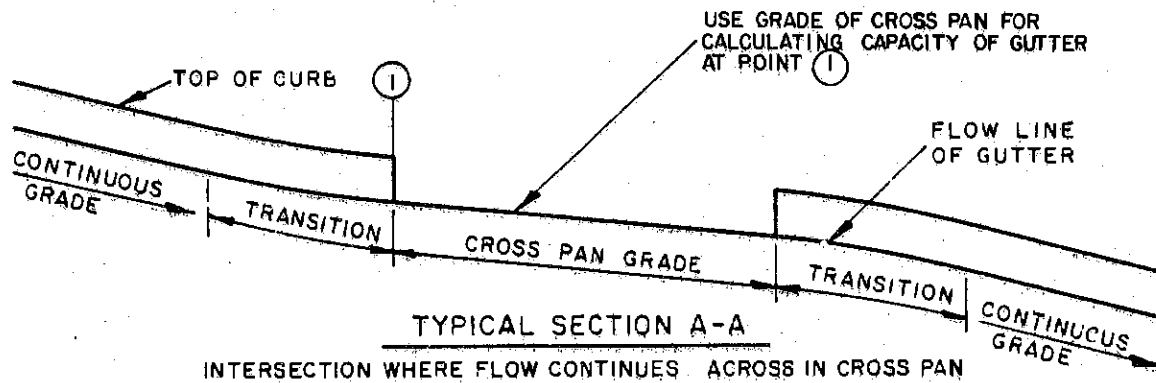
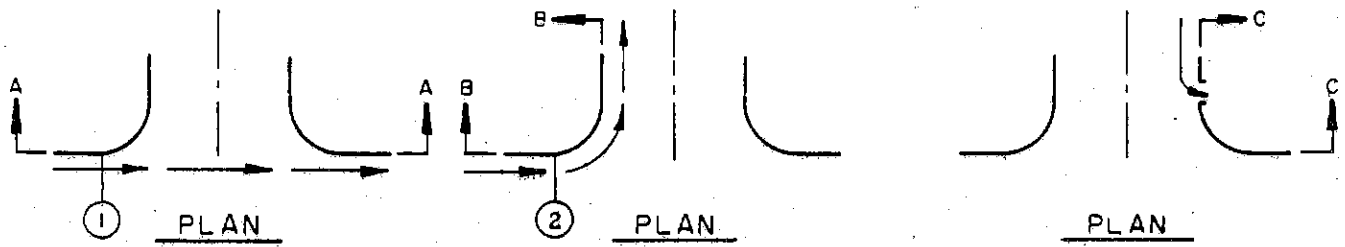

Figure 3-4 Intersection Drainage

theoretical gutter capacity. The slope used to determine the reduction factor shall be the same effective slope used to calculate the theoretical capacity.

#### **Gutter Capacity, Major Storm**

##### **Allowable Depth and Inundated Area**

The allowable depth and inundated area for the major storm shall be limited as set forth in Table 3-2.

##### **Theoretical Capacity**

The theoretical carrying capacity of each gutter approaching an intersection shall be calculated, based upon the most critical cross section.

The grade used for calculating capacity shall be as covered in Gutter Capacity, Initial Storm.

##### **Allowable Capacity**

The allowable capacity for gutters approaching an intersection shall be calculated by applying the reduction factor from Figure 3-3 to the theoretical capacity. The gutter grade used to determine the reduction factor shall be the same effective grade used to calculate the theoretical capacity.

##### **Ponding**

##### **Initial Storm**

The allowable pavement encroachment for the initial storm shall be as presented in Table 3-1.

##### **Major Storm**

The allowable depth and inundated area for the major storm shall be as presented in Table 3-2.

#### **Cross-Street Flow**

##### **Depth**

Cross-street flow depth at intersections shall be limited as set forth in Table 3-3.

##### **Theoretical Capacity**

The theoretical capacity shall be calculated at the critical point of the cross-street flow. Where cross-street flow will be conveyed across a local or collector street, the cross-sectional area used for calculations shall be along the centerline of the local street. The slope shall be the slope of the cross pan at that point.



### 3.40 Bibliography

1. Izzard, C.F., Hydraulics of Runoff from Developed Surfaces, Proc. Highway Reserach Board, Vol. 26, 1946.
2. National Research Council, Building Research Advisory Board, A Study of Invert Crown Residential Streets and Alleys, Federal Housing Administration, Washington, D.C., 1957.
3. Oglesby, Clarkson H., Highway Engineering, 3rd ed., John Wiley and Sons, Inc., New York, NY, 1975.
4. Searcy, J.K., Design of Roadside Drainage Channels, U.S. Bureau of Public Roads, Hydraulic Design Series No. 4, U.S. Government Printing Office, Washington, D.C., 1965.
5. Wright-McLaughlin Engineers, Urban Storm Drainage Criteria Manual, Denver Regional Council of Governments, CO, 1969.

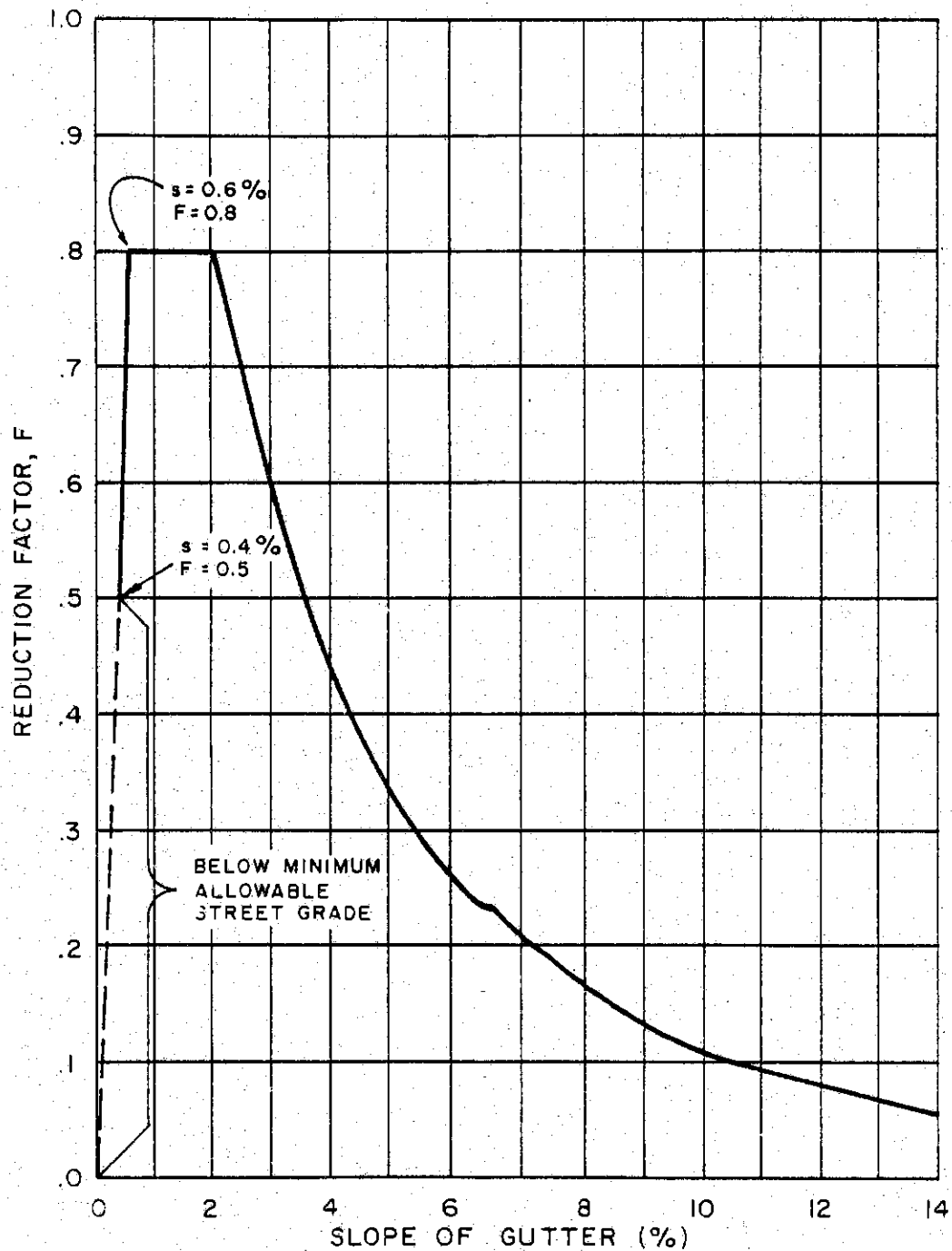

APPLY REDUCTION FACTOR FOR APPLICABLE SLOPE TO THE THEORETICAL GUTTER CAPACITY TO OBTAIN ALLOWABLE GUTTER CAPACITY APPROACHING ARTERIAL STREET.

Figure 3-5 Reduction Factor for Allowable Gutter Capacity When Approaching an Arterial Street

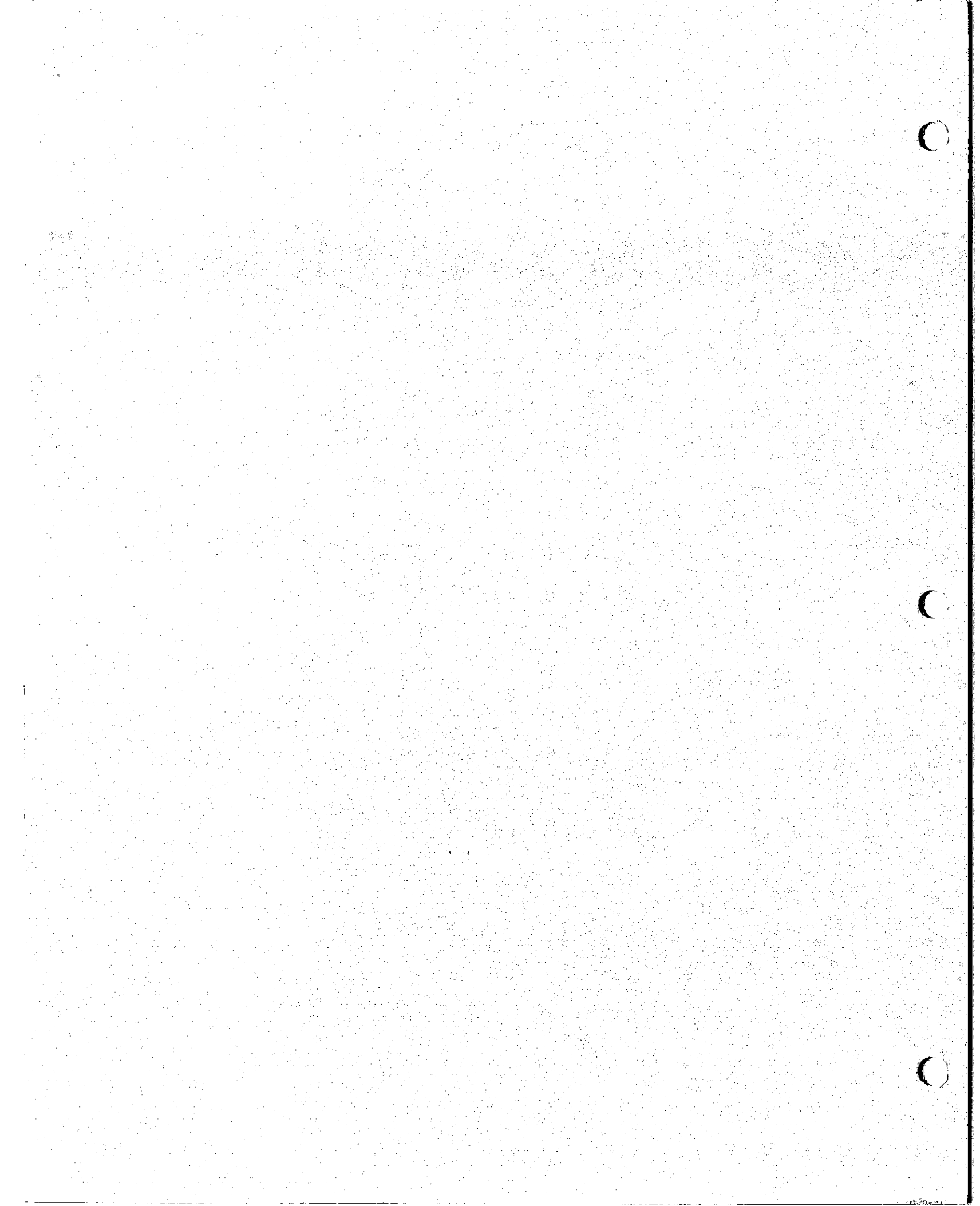

## Section 4

### Storm Inlets

- 4.10 Inlet Types
- 4.20 Inlets on a Grade
- 4.30 Comparison of Inlet Types
- 4.40 Grate Inlets
  - Capacity of Grate Inlets on a Continuous Grade
  - Capacity of Grate Inlets in a Sag
- 4.50 Curb-Opening Inlets
  - Capacity of Curb-Opening Inlets on a Continuous Grade
    - Composite Section
    - Explanation of Operation of Inlet
    - Computation by Electronic Calculator
    - Checking for Greater Storms
  - Capacity of Curb-Opening Inlets in a Sag
- 4.60 Combination Inlets
- 4.70 Inlet Location
  - Spacing of Inlets on a Continuous Grade
  - Spacing of Inlets in a Sag
- 4.80 Definition of Symbols for Section 3 and 4
- 4.90 Bibliography

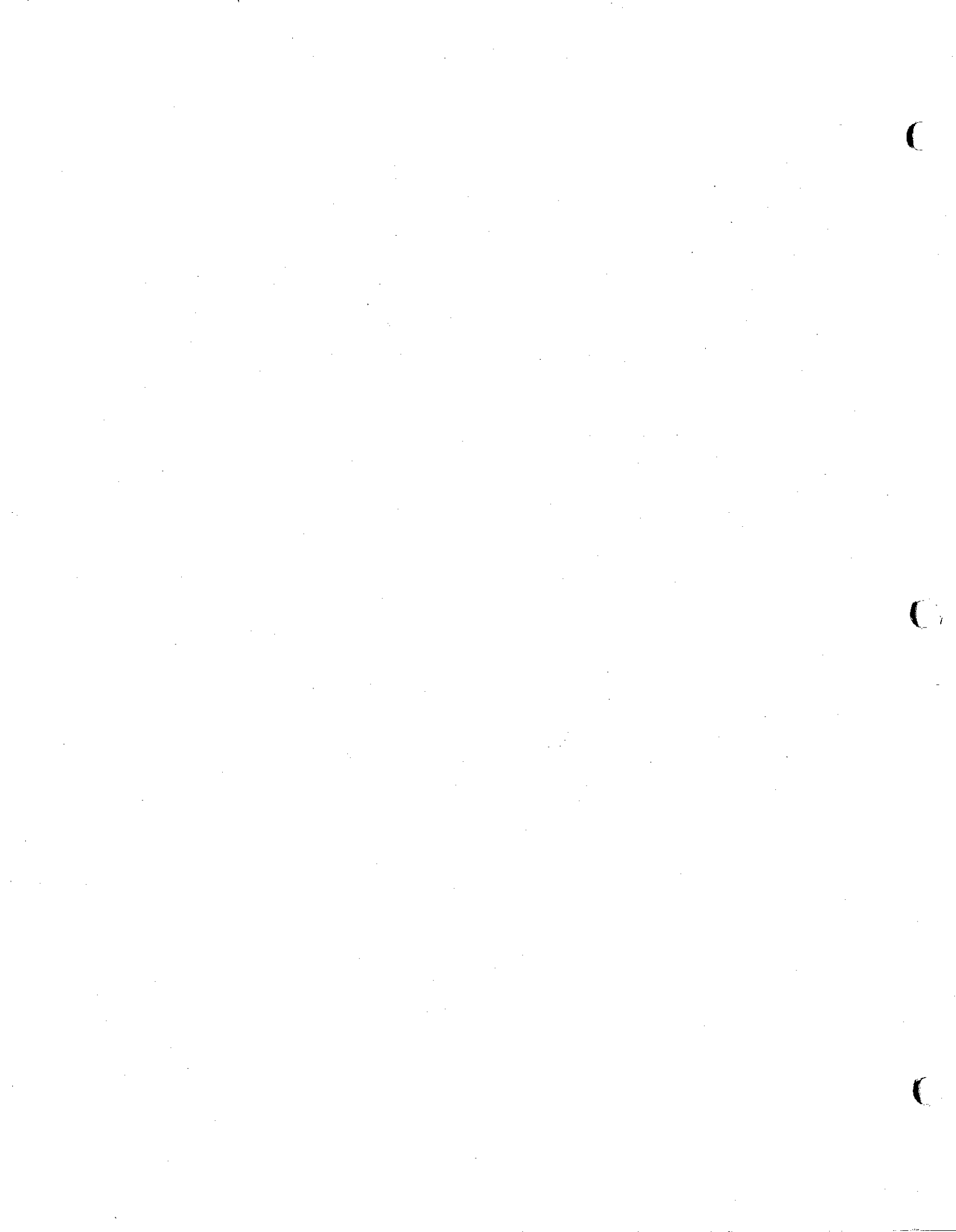

## Section 4

### Storm Inlets

The hydraulic capacity of a gutter inlet depends upon its geometry and upon the characteristics of the gutter flow. The inlet capacity governs both the rate of water removal from the gutter and the amount of water that can enter the storm drain system. Many costly storm drains flow at less than design capacity because the storm runoff cannot get into the drains. Inadequate inlet capacity or poor inlet location may cause flooding on the traveled way which creates a safety hazard or at times interrupts traffic.

In addition to its hydraulic function, the inlet is frequently located in or near the path of vehicular traffic. Water-borne debris and trash may be deposited on the inlet causing complete or partial clogging. Often freedom from clogging and noninterference with traffic requires an inlet of a specific type rather than the most efficient inlet from a hydraulic point of view. For example, a curb-opening inlet might be used where a grate inlet would be more efficient.

See Section 4.8 for definitions of symbols.

#### 4.10 Inlet Types

Gutter inlets can be divided into three major classes, each with many variations. These classes are (1) curb-opening inlets, (2) grate inlets, and (3) combination inlets (See Figure 4-1). Each type of inlet shall be installed with a depression of the gutter and may be a single or a multiple inlet (two or more closely spaced inlets acting as a unit). Two identical units placed end to end are called double inlets.

A brief description of the inlet types follow:

1. Curb-opening inlets. These inlets consist of a vertical opening in the curb through which the gutter flow passes.
2. Grate inlets. These inlets consist of an opening in the gutter covered by one or more grates.
3. Combination inlets. These units consist of both a curb-opening and a grate inlet acting as a unit.

#### 4.20 Inlets on a Grade

The term inlet capacity is used here to mean the catch of the inlet under a given set of conditions rather than the maximum water that can be intercepted by the inlet if the discharge is increased without limit. The efficiency of an inlet is the discharge intercepted by the inlet,  $Q_1$ , divided by the flow in the gutter,  $Q$ . The discharge that bypasses the inlet,  $Q_c$ , is termed carry-over.

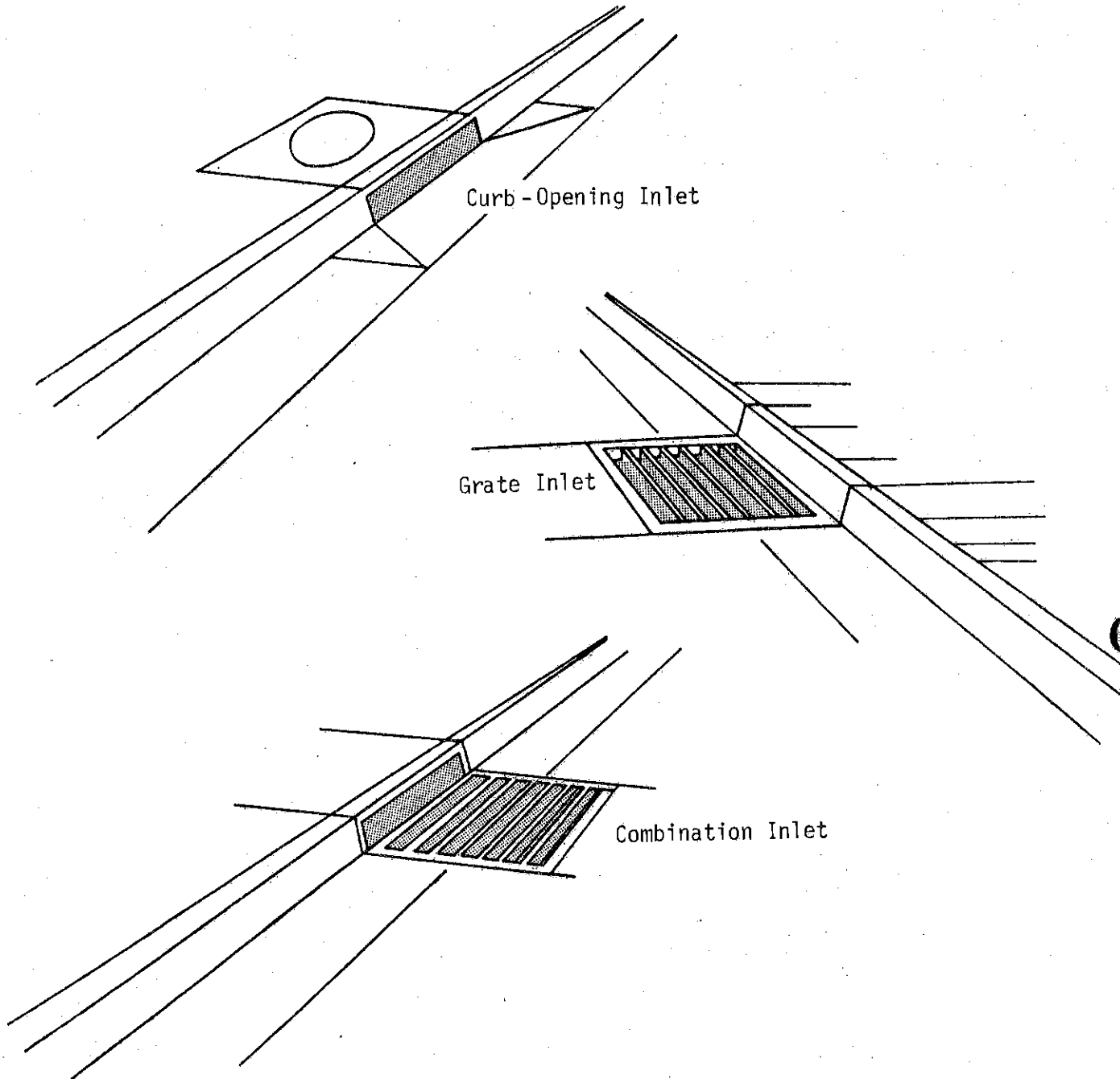

Figure 4-1 Inlet Types

A major factor in the capacity of a curb-opening inlet is the depth of water in the gutter immediately adjacent to the opening. The capacity of an efficient grate inlet depends principally upon the quantity of water flowing in the section formed by projecting the grate width upstream. Thus, an increase in longitudinal slope reduces inlet capacity (except for some grates or where deflectors are used) while an increase in transverse (cross) slope increases inlet capacity. Increase in length of a curb-opening inlet and increases in width of a grate opening increases the capacity of the inlet. For grate inlets, the efficiency of the grate opening is an important factor in inlet capacity.

For a curb-opening inlet, depressing the gutter increases the capacity of the inlet. The amount of the depression has more effect on the capacity than the arrangement of the depressed area with respect to the inlet.

Most investigators have pointed out that the capacity of an inlet is greatly increased by allowing a small percentage of the flow to bypass the inlet. For a given gutter discharge, the catch of each additional increment of width (grate inlets) or length (curb-opening inlets) becomes rapidly less. Thus, the cost of catching the small amount of flow near the thin edge of the triangular flow channel approaches the cost of catching the greater amount flowing nearer to the curb.

#### 4.30 Comparison of Inlet Types

A curb-opening inlet generally requires a larger structure than a grate inlet of equal capacity but the curb opening is located back of the curb line and offers little interference with roadway traffic.

Figure 4-2, plotted from data in Reference 2, gives a comparison of the capacity of several inlet types at about the maximum cross slope recommended for low-type surfaces. These curves are for an inlet efficiency of 95 percent and apply to a particular condition. They are presented for reference in the discussion which follows and should not be used for design curves.

An undepressed curb-opening inlet (Curve 1) has less capacity than a depressed curb-opening inlet (Curve 2). Curb-opening inlets lose capacity rapidly with increase in longitudinal grade. Grate inlets generally lose capacity with increase in grade but to a lesser degree (Curve 5). A very efficient grate designed at Johns Hopkins University (Curve 4) gains in capacity with increase in grade. Deflector vanes (Curve 3) increase the capacity of curb-opening inlets with increase in grade. A combination inlet (Curve 6) without depression has slightly greater capacity than the grate inlet alone (Curve 4). Changes in cross slope affect the capacity of a curb-opening inlet much more than the capacity of a grate inlet.

The choice of inlet cannot always be made upon capacity alone. Debris carried by the gutter flow and interference with vehicular traffic must also be considered. Curb-opening inlets are relatively free of debris clogging while grate inlets have a tendency to clog and might clog completely where debris is a problem. Combination inlets are better than grate inlets alone



INTAKE CAPACITY  
AT 95 PERCENT CAPTURE OF GUTTER FLOW

Manning's n = 0.013

Cross slope = .0417 ft per ft.

- |         |  |
|---------|--|
| Curve 1 | Curb Opening, no depression L=10 ft              |
| Curve 2 | Curb Opening, 2-1/2-inch depression, L=10 ft     |
| Curve 3 | Curb Opening, 3-ft-wide deflector, L=8.33 ft     |
| Curve 4 | Grate, no depression, W=2.5 ft, L=2.5 ft         |
| Curve 5 | Grate, 2-1/2-inch depression, W=2.5 ft, L=2.5 ft |
| Curve 6 | Combination, no depression                       |
| Curve 7 | Combination, 2-1/2-inch depression               |

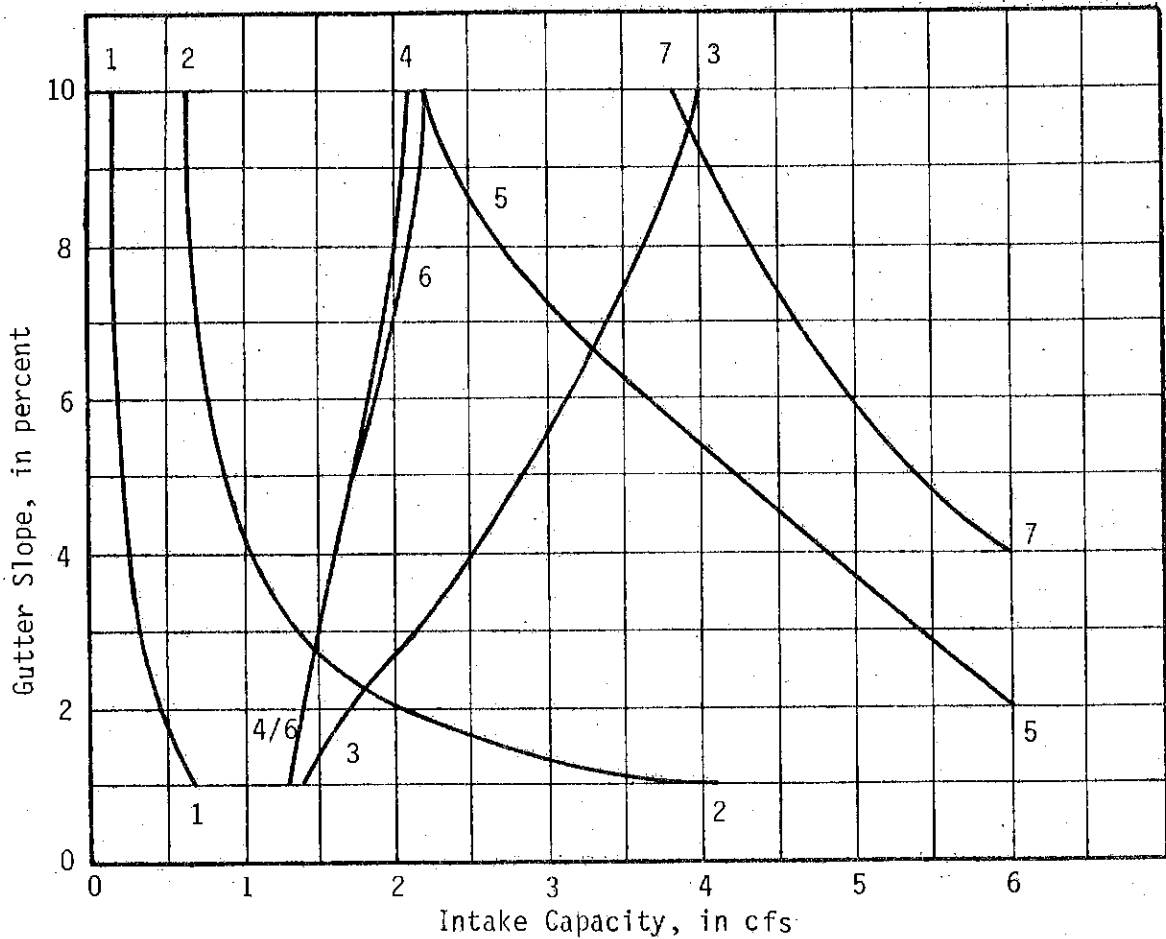

Figure 4-2 Comparison of Inlets

where debris is prevalent. From a water quality standpoint, the elimination of debris from the storm sewer system can be achieved by the use of grate inlets.

Grates with bars parallel to the flow, while much more efficient hydraulically, are hazardous to bicyclists if spacing between bars is wide. Curb-opening inlets with vertical openings greater than 5 inches create a potential hazard to pedestrians. The Johns Hopkins tests found that a few small rounded crossbars installed at the bottom of the longitudinal bars as stiffeners or as a safety stop for bicycle wheels, did not materially affect the capacity of the grate.

#### 4.40 Grate Inlets

Grate inlets are best suited for areas where traffic does not travel close to the curb and where clogging with debris is not a problem. Grate inlets are required in areas where the existing sewer system is a combined storm and sanitary sewer system. When the longitudinal grade exceeds about one percent, grates with rectangular longitudinal bars (parallel to flow) are much more efficient than grates with transverse (normal to flow) rectangular bars. As the grade increases, longitudinal bar grates become increasingly superior to transverse bar grates both in regard to interception of flow and decrease in tendency to catch debris. For example, the Johns Hopkins test found that on a 10 percent street grade with cross slope 1:18 and gutter flow of 3 cfs, a gutter inlet with longitudinal bars intercepted 2.7 cfs as compared with 1.9 cfs interception by a grate with transverse bars. However, some cross-bar grates of special design with bars curved in the vertical plane have been found in manufacturers tests to intercept more of the flow than longitudinal bar grates. A direct comparison between manufacturer's tests and those reported in the references cannot be made because of differences in testing conditions. In general, an unclogged, efficient, grate inlet on a continuous grade will intercept all water flowing within a width equal to that of the grate.

For an efficient grate inlet, all rectangular bars should be parallel with the flow and the openings should cover at least 50 percent of the width of the grate. The clear length of the opening should be sufficient to allow the water to fall through the openings without striking the far end of the grate. The required clear length of the bar ( $L_b$ ) can be computed by the experimentally determined formula:

$$L_b = \frac{V}{2} (d + d_b)^{0.5} \quad (4-1)$$

where:

$L_b$  = length of clear opening of grate, in feet;

$V$  = mean approach velocity in the width of the grate opening, in feet per second;

$d$  = depth of flow at the curb, in feet; and

$d_b$  = depth of the bar, in feet.

Figure 4-3 is a graphical solution of the above equation for pavement with roughness coefficient  $n = 0.015$  and depth of bar 3-1/2 inches. The effect of gutter slope on the length of clear opening needed for an efficient grate is shown by Example 1.

#### Example 1

**Given:** Pavement and gutter cross slope,  $S_x = 1/4$  inch per foot (0.021 foot per foot); 2-foot concrete gutter;  $n = 0.016$ ; allowable spread on pavement, 6 feet (total width of gutter, 8 feet); depth of grate bars, 3-1/2 inches.

**Find:** Length of clear opening of grate bars required for an efficient grate when longitudinal slope ( $S_0$ ) is one percent; 10 percent.

**Solution:**

1. Use Figure 4-3. On upper left diagram for  $T = 8$  feet move horizontally to  $S_x$  curve, 0.021.
2. From intersection in Step 1 move vertically downward to  $S_x$  curve, 0.021 in left center diagram.
3. From intersection in Step 2, move horizontally to the right diagram and read  $L_b$  on bottom scale at the intersection of the curve for  $S = 0.01$ , 1.1 feet, and at intersection of curve for  $S = 0.10$ , 3.0 feet.

Example 1 shows that as the gutter slope varies so does the length of clear opening required for 100 percent interception of the water approaching the inlet within the width of the grate. A practical solution might be the adoption of several grates with different lengths of clear openings. Each length of grate would have a range of slopes for which it would be the most appropriate grate to use. If the length of clear opening is less than given by the above equation, some of the gutter flow will pass directly over the grate without being intercepted and add to the flow bypassing the grate.

#### Capacity of Grate Inlets on a Continuous Grade

The capacity of an undepressed efficient grate inlet can be determined by computing the flow in the section occupied by the grate width.

For straight-line sections, the flow intercepted by an undepressed efficient grate can be computed as explained in Instruction 3, Figure 3-2. Example 2 illustrates the procedure.

### Example 2

**Given:**  $Q = 1.5$  cfs; pavement cross slope,  $S_x = 1/4$  inch per foot;  $n = 0.016$ ; longitudinal slope = 2 percent; grate inlet, 30 inches wide by 24 inches long; depth of longitudinal bars, 3 inches; no cross bracing; 60 percent clear opening.

**Find:** Spread on the pavement and the discharge intercepted by the grate inlet.

**Solution:**

1.  $Z = \frac{1}{S_x} = 48.00$
2.  $\frac{Z}{n} = 3,000$
3. On Figure 3-2, lay a straight edge on  $Z/n = 3,125$  and slope = 0.02. Mark intersection of straight edge on the turning line.
4. Lay straight edge on turning point marked in Step 3 and the discharge, 1.5 cfs. Read depth of flow at the curb = 0.15 feet.
5. The spread on the pavement is  $Zd$  or  $48 (0.15) = 7.20$  feet.
6. Depth of flow at outward edge of grate ( $X = 2.5$ ) is  $d - \frac{(X)}{(Z)}$  or  $0.15 - \frac{(2.5)}{(48.0)} = 0.10$  feet.
7. From Figure 3-2 (following Steps 3 and 4) for  $d = 0.10$  feet,  $Z/n = 3,000$ , and  $S = 0.02$ , read  $Q_c = 0.5$  cfs.
8. Then  $Q_i = 1.5 - 0.5 = 1.0$  cfs, provided the grate is efficient.
9. The grate has the necessary requirements for efficiency (Section 4.5) if the clear opening ( $L_b$ ) is sufficient. The mean velocity in the 2.5-foot section over the grate is 1.0 cfs (Step 8) divided by the area of the section (0.15-foot deep at the curb and 0.10-foot deep at the other edge of grate), or 3.20 feet per second. The clear opening required by equation (4) is:

$$L_b = \frac{V}{2} (d + d_b) 0.5 = \frac{3.20}{2} (.15 + .25) 0.5 = 1.0 \text{ feet}$$

The grate opening, 2.0 feet, exceeds that required. Thus, the grate is efficient.

The 2.5-foot grate intercepts 67 percent of the total flow,  $1.0/1.5 = .67$ , in Example 2. To intercept 100 percent of the flow would require a grate 7.2 feet wide (Step 5), almost three times the width required for 67 percent interception.

Ordinarily, the width of the grate remains constant and the spacing of inlets are varied to limit the spread on the pavement to the desired quantity. The calculations for determining the discharge for 100 percent interception by a given grate are shown in Example 3.

### Example 3

#### Total Interception by Undepressed Grate

Given: The same conditions as in Example 2.

Find: The gutter flow (Q) that would be totally intercepted by an efficient grate inlet, 30-inches wide.

Solution:

1. The spread on the pavement ( $T = Zd$ ) is limited to the grate width (2.5 feet) for 100 percent interception. For a spread of 2.5 feet,  $d = \frac{2.5}{48.0} = 0.05$  feet.
2. From Figure 3-2 (following Steps 3 and 4 of Example 3), for  $d = 0.05$ ,  $Z/n = 3,000$ , and  $S = 0.02$ ,  $Q = 0.08$  cfs.

Examples 2 and 3 show the advantage of designing grate inlets for partial interception. For 100 percent interception under the conditions of these examples, the grate width would have to be tripled, or about 19 separate 30-inch grate inlets, each intercepting 0.08 cfs, would be required.

For composite straight-line gutter sections, the flow intercepted by an undepressed efficient grate is computed as explained by Instruction 4 on Figure 3-2.

#### Capacity of Grate Inlets in a Sag

A grate inlet in a sag operates first as a weir having a crest length roughly equal to the outside perimeter (P) along which the flow enters. Bars are disregarded and the side against the curb is not included in computing P. Weir operation continues to a depth (d) of about 0.4 feet above the top of grate and the discharge intercepted by the grate is:

$$Q_i = 3.0 P d^{1.5} \quad (4-2)$$

where:

$Q_i$  = rate of discharge into the grate opening, in cubic feet per second;

P = perimeter of grate opening, in feet, disregarding bars and neglecting the side against the curb; and

d = depth of water at grate, in feet.

When the depth at the grate exceeds about 1.4 feet, the grate begins to operate as an orifice and the discharge intercepted by the grate is:

$$Q_i = 0.67A (2gd)^{0.5} = 5.37Ad^{0.5} \quad (4-3)$$

where:

$Q_i$  = rate of discharge into the grate opening, in cubic feet per second;

$A$  = clear opening of the grate, in square feet;

$g$  = acceleration of gravity, 32.2 feet per second<sup>2</sup>; and

$d$  = depth of ponded water above top of grate, in feet.

Between depths over the grate of about 0.4 feet and about 1.4 feet the operation of the grate inlet is indefinite due to vortices and other disturbances. The capacity of the grate is somewhere between that given by the above equations.

Because of vortices and the tendency of trash to collect on the grate, the clear opening or perimeter of a grate inlet should be at least twice that required by the equations in order to remain below the design depth over the grate. Where the danger of clogging is slight, a factor of safety less than two might be used. If a combination inlet is used, the grate need only be as large as given by the equations because the curb opening provides the safety factor from clogging.

These equations are solved graphically with Figure 4-4. The dashed lines on this figure represent the range where neither weir nor orifice operation is fully effective. Example 4 illustrates the procedure.

#### Example 4

**Given:** Grate inlet, 2 feet by 2.5 feet with 50 percent clear opening, located in a sag with one 2-foot side against the curb.

**Find:**

1. Depth of water when  $Q = 0.9$  cfs; and
2. Depth of water when  $Q = 20$  cfs.

**Solution:**

1. Compute perimeter of grate opening ( $P$ ) ignoring the bars and omitting any side over which the water does not enter, such as when one side is against the face of a curb. Divide the result by 2 to allow for partial clogging of the grate.

$$P = 2 + 2.5 + 2.5 = 7.0 \text{ feet}$$

$$\text{Effective } P = \frac{7}{2} = 3.5 \text{ feet}$$

2. Compute  $\frac{Q}{P}$  ratio, using effective perimeter.

$$(1) \frac{0.9}{3.5} = 0.26$$

$$(2) \frac{20}{3.5} = 5.71$$

3. Compute the total area of clear opening (A), excluding area taken up by bars, and divide by 2 to allow for partial clogging of the grate.

$$\text{Clear opening} = .50 (2 \times 2.5) = 2.5 \text{ square feet}$$

$$\text{Effective area} = \frac{2.5}{2} = 1.25 \text{ square feet}$$

4. Compute  $\frac{Q}{A}$  ratio, using effective area

$$(1) \frac{0.9}{1.25} = 0.72$$

$$(2) \frac{20}{1.25} = 16.0$$

5. Enter Figure 4-4 at the abscissa, using curve A with  $\frac{Q}{P}$  values up to 3.0 feet and curve B with  $\frac{Q}{A}$  values above 3.0 feet, and read the depth, in feet, of ponding over the grate.

$$(1) d = 0.20 \text{ feet from curve A. No intercept on curve B for } \frac{Q}{A} = 0.72.$$

$$(2) \text{ No intercept on curve A for } \frac{Q}{P} = 5.71.$$

$$\text{For } \frac{Q}{A} \text{ of } 16.0, d = 8.9 \text{ feet}$$

If the grate has appreciable cross slope so that the side away from the curb is higher than the curb side, the inflow over the side should be determined separately from that over the ends. In weir control, use the depth at the middle of the grates for end inflow and the depth away from the curb for side inflow.

#### 4.50 Curb-Opening Inlets

Curb-opening inlets are used in many locations because they offer little interference to traffic and are relatively free from clogging by debris.

The curb-opening inlet discussed in this section is illustrated in Figure 4-5. It has a depression beginning  $W$  feet away from the curb and dropping 1 inch per foot below the plane of the pavement. Transitions at the two ends extend  $W$  feet from the end of the opening. The height of the opening need not be more than 4 inches since the water surface draws down as it accelerates on the depression apron. The opening should not exceed 5 inches in height in order to prevent a potential pedestrian hazard. The equations given apply only if the cross section of the street has a uniform slope to the face of the curb.

#### Capacity of Curb-Opening Inlets on a Continuous Grade

The operation of a curb-opening inlet on a grade is usually described in terms of the ratio of the flow intercepted  $Q_i$  to the approach flow  $Q$  which extends a distance  $T$  from the curb face.  $Q_i/Q$  can be defined in a dimensionless plot against  $L_i/(F_w T)$  where  $L_i$  is the length of the inlet opening and  $F_w$  is the Froude Number related to the depth of the approach flow at a distance  $W$  from the curb (See Figure 4-6.) This is along a line at the outer edge of the inlet depression. The Froude Number is a ratio of the kinetic energy to the gravity force acting on the flow in the gutter.

Figure 4-6 is drawn for a cross slope,  $S_x = 0.015$  and  $W = 2$  ft. Note that  $Q_i/Q = L_i/L_1$  up to the point where the parameter  $L_i/F_w T = 0.4$ . Beyond that point the relationship changes abruptly to a curved line for which  $Q_i/Q = (L_i/L_3)^{0.4}$ .  $L_1$  is the value of  $L_i$  where the straight line intersects  $Q_i/Q = 1.0$ , while  $L_3$  is the value of  $L_i$  where the curved line intersects  $Q_i/Q = 1.0$ .  $L_2$  is the value of  $L_i$  at the breakpoint between the straight and curved lines.

From the diagram, it is apparent that if we know the value of  $F_w T$  and  $L_i$ , the value of  $Q_i/Q$  can be found from the ordinate scale. Remember that this diagram is for specific values of  $S_x$  and  $W$ . The position of the  $S_x$  line varies with these variables in accordance with the equations on Figure 4-6 while the position of the curved line remains fixed. Solutions for  $Q_i/Q$  may be read from Figure 4-7 for  $W = 2$  feet or may be computed using an electronic calculator and the equations tabulated in the examples in Table 4-1. This Table also gives the equations for  $F_w$  and  $Q$  in terms of the cross-section variables.

#### Use of Figure 4-7

An example in dotted lines illustrates the use of Figure 4-7. The depth of flow  $d_w$  in the street section at a point  $W$  ft from the curb face is the starting point.



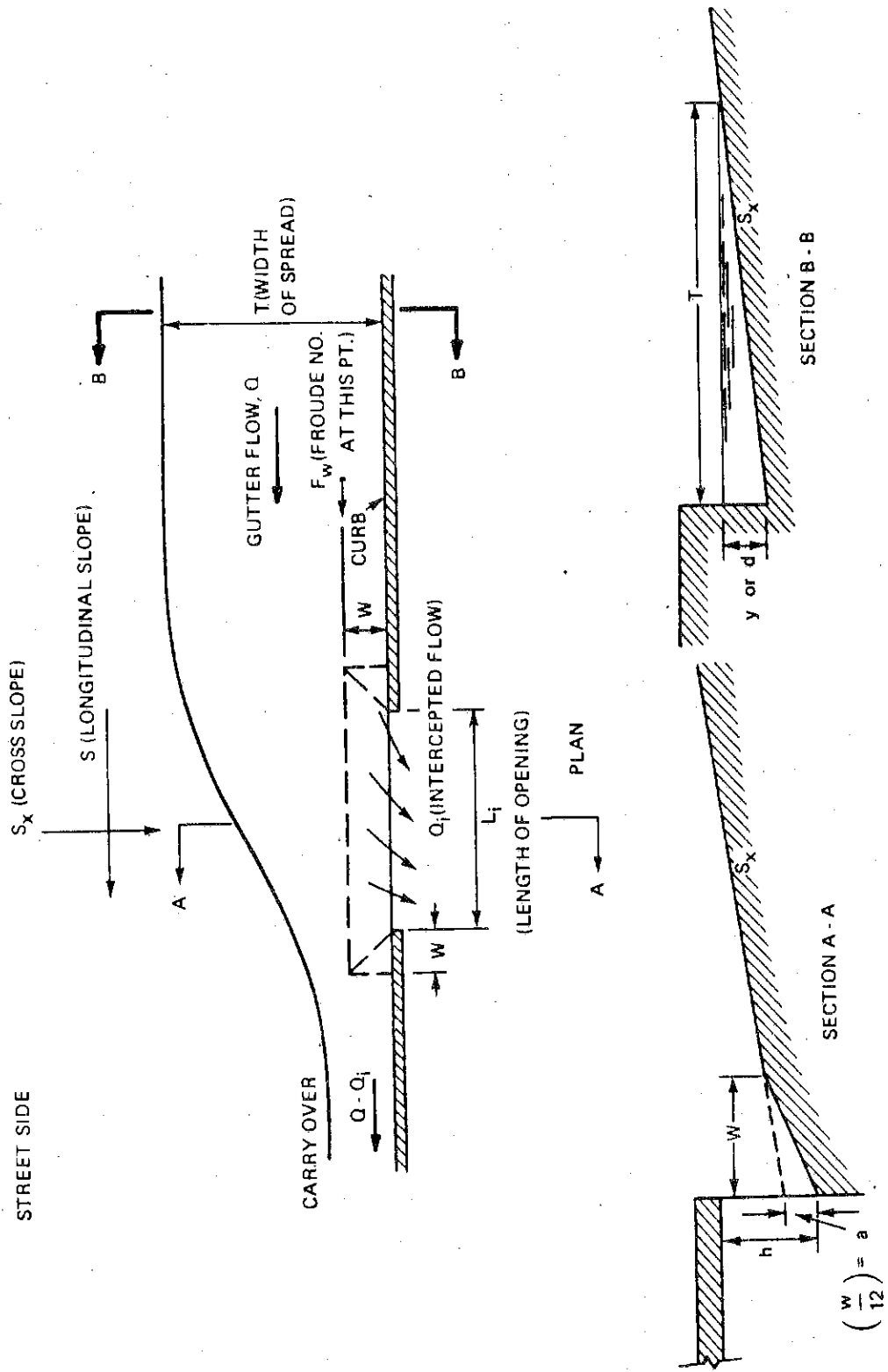

Figure 4-5 Graphical Definition of Symbols

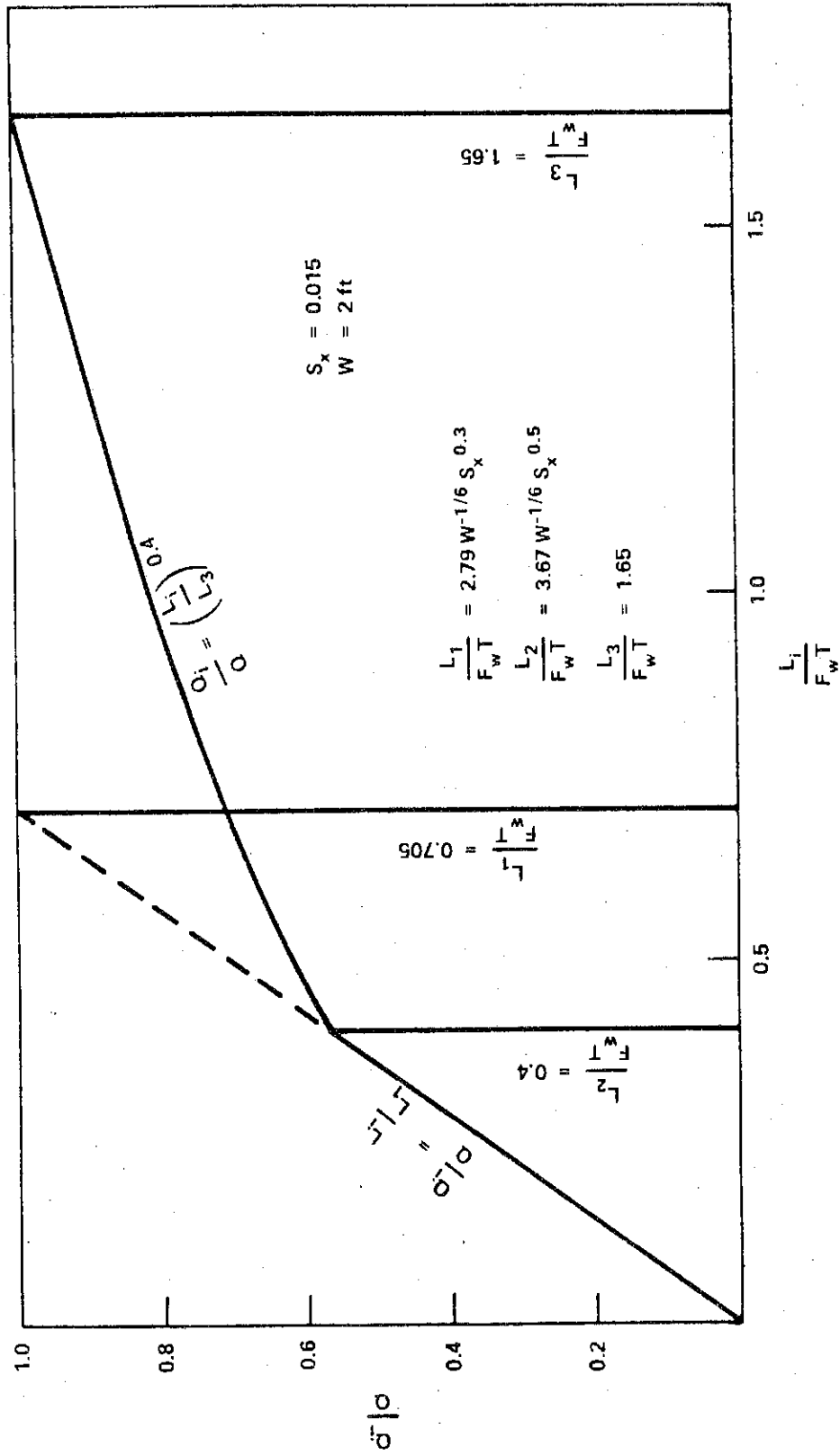

Figure 4-6 Dimensionless Graph of  $Q_i/Q$  vs.  $L_i/F_w T$

1. Enter with  $S_x$  (T-2) at top.
2. Follow down to line for  $n$ , normally 0.016.
3. Move across to longitudinal slope,  $S$ .
4. Follow down to spread,  $T$ ; this establishes a horizontal line.
5. If  $Q_i/Q$  is given, enter with  $Q_i/Q$  (upper right) follow across to Limit Line A, or line for  $S_x$ , whichever is intersected first.
6. Move down to lower margin ( $Q_i/Q = 0.1$ ) and then diagonally to intersection with line from Step 4.
7. Follow down to length of inlet,  $L_i$ .
8. The horizontal line can be extended to line  $L_3$  for 100% interception, then down to  $L_3$ .
9. If length of inlet is given, enter with that length, move up to horizontal line established in Step 4, diagonally to  $Q_i/Q = 0.1$ , then vertically to  $S_x$  (or line A) and across to  $Q_i/Q$ .

#### Composite Section

It is a common practice to build gutters with steeper cross slopes than the pavement. This increases the depth of flow at the curb and the discharge for a given spread. Assuming that the width of the gutter is the same as the width  $W$  of the inlet depression, it is probable that the increment in flow caused by the steepened gutter cross slope will be picked up by the inlet. On that basis a family of curves has been calculated by the method given in Figure 3-2 to give the ratio of the increased flow to the flow in the straight section in Figure 4-8. To use this figure, first estimate  $Q$  by methods described previously, then, knowing  $S_x$  and  $T$ , read  $Q_i/Q$  on the ordinate scale and multiply by  $Q$  to obtain the increment in discharge to be added to  $Q_i$ .

#### Explanation of Operation of Inlet

It may be helpful to discuss the physical significance of the dimensionless curves in Figure 4-6. If we think of  $F_w T$  as a constant for a given case of flow, then the abscissa scale is the length of inlet divided by that constant. We could recalibrate the scale to read directly in feet for inlet length. For short inlets, up to the length  $L_2$  where the curve breaks, the inlet is acting as a weir. In fact, the flow intercepted is practically the same as would be intercepted by the same inlet at a sump, using the modified weir equation for that case. The major part of the flow is intercepted (60% or more depending on  $S_x$ ) up to the length  $L_2$ . For greater lengths of inlet, the remainder of the flow moves in gradually as indicated by the lesser increments of  $Q_i$  as length increases.

Table 4-1

Computations for Curb - Opening Inlets

$$(7) \frac{Q_i}{Q} = \frac{L_i}{L_1}$$

$$(8) \frac{Q_i}{Q} = \left(\frac{L_i}{L_3}\right)^{0.4}$$

$$(4) F_w = 16.4 \left[ (T-2) S_x \right]^{1/6} S_o^{1/2}$$

$$(5) Q = 35 S_x^{5/3} T^{8/3} S^{1/2} = 0.0515 T^{8/3} S_o^{1/2}$$

$$(6) T = \left[ \frac{Q}{35 S_x^{5/3} S^{1/2}} \right]^{3/8} S_x^{-5/8} = 3.04 \left( \frac{Q}{S_o^{1/2}} \right)^{3/8}$$

$$(1) L_1 = 2.49 S_x^{0.3} F_w T$$

$$(2) L_2 = 3.27 S_x^{0.5} F_w T$$

$$(3) L_3 = 1.65 F_w T$$

STANDARD SECTION

W=2 ft.  
n=0.016  
S\_x=0.02

INLET NO.	S	Q S <sup>1/2</sup> (cfs.)	T (5) (cfs.)	F <sub>w</sub> S <sup>1/2</sup> (7)	F <sub>w</sub> T (8)	L <sub>1</sub> (9) (ft.)	L <sub>2</sub> (10) (ft.)	L <sub>3</sub> (11) (ft.)	Q <sub>i</sub> Q (12) 1.0*	Q <sub>i</sub> (13) (cfs)	Q <sub>2</sub> Q (14) .600 (cfs)	L <sub>i</sub> (ft.)		USE L <sub>1</sub> (ft.)	ACT. Q <sub>i</sub> (cfs)	Q-Q <sub>i</sub> =Q <sub>C</sub> (cfs)		
												Q <sub>i</sub> < Q <sub>2</sub> L <sub>1</sub> < L <sub>2</sub>	Q <sub>i</sub> > Q <sub>2</sub> L <sub>1</sub> > L <sub>2</sub>					
(1)	(2)	(3)	(4)	(5)	(6)	(7)	(8)	(9)	(10)	(11)	(12)	(13)	(14)	(15)	(16)	(17)	(18)	(19)
1	.01	23.9	2.39	10.0*	12.1	1.21	12.1	20.0	1.0*	2.39	1.43	2.39	1.43	20.0	20.0	20.0	2.39	0
1	.01	23.9	2.39	10.0*	12.1	1.21	12.1	20.0	0.80*	1.91	1.43	1.91	1.43	11.4	12.0	12.0	1.95	0.44
2			2.83	10.7	12.2	1.22	12.2	20.1	0.81	2.26	1.70	2.26	1.70	11.9	12.0	12.0	2.30	0.53
3			2.92	10.8	12.3	1.23	12.3	20.3	0.81	2.37	1.75	2.37	1.75	11.9	12.0	12.0	2.37	0.55
3	alternate								0.99						20.0	20.0	2.90	0.02
4	.03	23.9	4.14	10.0	12.9	2.24	22.4	37.0	0.58	2.40	2.48	2.40	2.48	10.0*	10.0*	10.0*	2.40	1.74
4	alternate 1								0.80*	3.31				21.1	22.0	22.0	3.36	0.78
4	alternate 2		0.65	5.0		2.05	10.25	16.9	0.80*	0.52	0.39	0.52	0.39	10.0*			0.53	0.12

(See text for sequence of computations)

\* Required criteria

One foot is 0.3048m

One cubic foot is 0.0283m<sup>3</sup>

## Computation by Electronic Calculator

For those who prefer using an electronic calculator, Table 4-1 illustrates the sequence of steps. As a rule, the designer will be working with a standard inlet and cross section for which  $S_x$ ,  $n$  and  $W$  are fixed. In the heading Equations (1), (2), and (3), taken from those in Figure 4-6, reduce to the numerical coefficients in the heading of Columns (9), (10), and (11).

On the first line, Inlet 1, the designer is to find the inlet length required for 100% interception on a 1% grade with  $T = 10$  ft. The starred numbers represent the required criteria. Column 3 is used if there are a succession of grades for which  $Q$  is computed by Equation (5). Similarly Column 6 is for  $F_w$  computed by Equation (4). Multiplying  $F_w T$  in Column 8 by the coefficients in the headings of Columns 9, 10, and 11 gives characteristic lengths  $L_1$ ,  $L_2$ , and  $L_3$ . As stated  $Q_i/Q = 1$ , so  $Q_i$  in Column 13 equals  $Q$ .  $Q_2/Q$  for the standard conditions is simply  $0.462/0.770 = 0.600$ , as recorded in the heading for Column 14. Either Column 15 or Column 16 is used to record  $L_i$  depending on whether  $Q_i < Q_2$  or  $> Q_2$  (or in the case where  $L_i$  is given,  $L_i < L_2$  or  $> L_2$ ). In this case  $Q_i > Q_2$ , so  $L_i$  is computed by Equation (8). Since  $Q_1/Q = 1$ , then  $L_i/L_3 = 1$  and  $L_i = 20$  as taken from Column 11. Actually, for 100% interception one may go directly from Column 11 to Column 16. Column 17 records the selected length  $L_1$ , usually as a multiple of 2 feet depending on design standards. In the next example the computed length 11.4 becomes 12. If desired  $Q_i$  can then be recomputed by Equation (7) or (8) in Column 18 and subtracted from  $Q$  to give the carry-over discharge  $Q_c$ .

In the next three examples the independent variables are the same as the first example except that  $Q_i/Q = 0.8$ . For inlet 1, the required length reduced to 12 feet with  $Q_c = 0.44$  cfs. Assuming the increment in runoff for the next subwatershed is the same as for inlet 1, the second inlet will then have  $Q = 2.39 + 0.44 = 2.83$  cfs. This requires a recomputation of  $T$  as  $(2.83/2.39)^{3/8} 10 = 10.7$  feet in accordance with Equation (5).  $L_3$  changes slightly to 20.7. It is now assumed that the same size of inlet will be used again, so  $Q_i/Q$  is computed as  $(12/20.1)^{0.4} = 0.81$  making  $Q = 0.81(2.83) = 2.30$  cfs and  $Q_c = 0.53$  cfs. For inlet 3, again using 12 ft, the adjusted value of  $T$  becomes 10.8 and  $L_3 = 20.3$  which leaves  $Q_i/Q = 0.81$  and  $Q_i = 2.37$  cfs. The flow intercepted has now become substantially equal to the increment in runoff for the intervening watershed.

Supposing that Inlet 3 is just above an intersection making carry-over flow undesirable, the third inlet may be increased to 20 ft to intercept practically all the flow.

If 0.55 cfs can be allowed to pass by Inlet 3, then a cost saving with three 12-ft inlets can be realized by assuming  $Q_i/Q = 0.80$ .

In Inlet 4, it is assumed that a 10-ft inlet is to be used and  $Q_i/Q$  is to be found. In this case  $L_i = L_2$  so Equation (7) is used. For alternate 1, the length for  $Q_i/Q = 0.8$  is to be computed.

For Inlet 4, alternate 2, the problem is to find  $T$  which would enable the 10-ft inlet to intercept 80% of the flow. This would tell how far upstream the inlet would have to be moved to reduce  $Q$  to that amount. In this case

$(10/L_3)^{0.4} = 0.80$  so  $L_3 = (1/0.80)^{2.5} 10 = 17.5$  which must equal  $1.65 F_w T$ .  
 Therefore  $F_w T = 17.5/1.65 = 10.6$ . As a first trial assume  $F_w = 2.2$  making  $T = 10.6/2.2 = 4.8$ . Substituting this  $T$  in Equation (4) we find  $F_w = 2.03$ . A second trial with  $F_w = 2.1$  yields  $T = 5$  and gives a computed  $F_w = 2.05$  which is close enough. Taking  $T = 5$  by Equation (5),  $Q = 0.515(5)^{8/3} 0.03^{1/2} = 0.65$  cfs. This is an absurdly small discharge, demonstrating that a 10-ft inlet is ineffective on a 0.03 grade. Rather than moving the inlet that far upgrade, it would obviously be more economical to go to a 22-ft inlet at the original location and save the extra length of pipe.

#### Checking for Greater Storms

In checking drainage systems for performance with storms greater than the design storm note that the spread on the pavement increases as  $Q^{3/8}$ , other variables remaining constant. Thus, if runoff is doubled, spread increases only  $2^{3/8}$  or 1.3 times. Assuming the inlet has been designed for  $Q_i/Q = 0.80$ , this would reduce to about 0.7 but  $Q_i$  would increase about  $(0.7/0.8)^2 = 1.75$  times. One would then have to check the pipe capacity and particularly the head loss entering the pipe to see if the greater  $Q_i$  could be accepted. Depending on consequences of street flooding, consideration might be given to increasing the pipe capacity.

#### Capacity of Curb-Opening in a Sag

The capacity of curb-opening inlets in a sag depends upon the depth of water at the inlet and the inlet geometry. The inlet operates as a weir until the water submerges the entrance. When the water depth exceeds about 1.4 times the height ( $h$ ) of the curb-opening entrance, the inlet operates as an orifice. Between weir-type operation and orifice-type operation the capacity is indeterminate. Figure 4-9 gives the minimum height ( $h_m$ ) of opening required for weir type operation. If the opening height ( $h$ ) equals or exceeds  $h_m$ , Figures 4-10 to 4-12 will give the depth of ponding measured at the curb, just above the depressed area. The use of these charts is explained in Example 5.

Figures 4-10 thru 12 are based on experiments made at Colorado State University and apply to depressed curb-opening inlets with a height of opening equal or exceeding the appropriate  $h_m$  from Figure 4-9. When the inlet is not depressed, the approximate capacity can be computed by the weir equation:

$$Q_i = 3.0 L_i d_i^{1.5} \quad (4-4)$$

where:

$Q_i$  = capacity of the inlet, in cubic feet per second;

$d_i$  = depth of water above inlet lip, in feet; and

$L_i$  = length of clear opening, in feet.

When the depth at the opening exceeds 1.4  $h$ , the capacity may be computed by the equation:

$$Q_i = 0.67A \sqrt{2g \left(d_i - \frac{h}{2}\right)^{0.5}} \quad (4-5)$$

where:

A = area of opening, in square feet ( $hL_i$ ); and

h = height of opening, in feet.

#### Example 5

**Given:** A curb-opening inlet in a sag; pavement cross slope 0.03; concrete, broom finish ( $n = 0.016$ ); depression, width = one foot, amount one-inch; height of inlet opening = 0.50 feet; design discharge from both sides of the inlet,  $Q_1 = 2$  cfs,  $Q_2 = 8$  cfs; total  $Q = 10$  cfs.

**Find:** Maximum depth of ponding ( $d_{max}$ ) for  $L_i = 5$  feet, 10 feet, and 15 feet.

**Solution:**

1. Use Figure 4-9 to check adequacy of the opening height to maintain free fall in the inlet. For  $Q = 10$  cfs the requirements are:  $L_i = 15$  feet,  $h_m = 0.28$  feet;  $L_i = 10$  feet,  $h_m = 0.38$  feet;  $L_i = 5$  feet,  $h_m = 0.56$  feet. The opening height, 0.50 feet, exceeds the requirement for free fall for the 15' and 10' opening lengths and Figure 4-10 can be used to determine depth of ponding.

2. From Figure 4-10 the maximum ponding is:

$L_i$	15 feet	10 feet	5 feet
$d_{max}$	0.41 feet	0.52 feet	0.72 feet
T	13.7 feet	17.3 feet	24.0 feet

3. The maximum depth of ponding at the curb opening may be exceeded in the approach gutter, particularly on low flows. The depth of ponding in the gutter can be checked at the point where the gutter slope is 0.002 by using Figure 4-13.

For  $L_i = 15$  feet,  $Q_1 = 2$  cfs,  $d_{max} = 0.41$  feet (Step 2), and  $d = 0.3$  feet.

The gutter depth for  $Q_1$  is less than the ponding depth at the inlet and water will back up in the gutter channel.

For  $Q_2 = 8$  cfs,  $d_{max} = 0.41$  feet (Step 2), and  $d = 0.5$  feet (Figure 4-13).

The gutter depth for  $Q_2$  is greater than the ponding depth at the inlet and the water profile tends to draw down on approaching the inlet.

For  $L_i = 10$  and 5 feet,  $d_{max} = 0.52$  or 0.72 feet (Step 2), and  $d = 0.3$  or 0.5 feet.

The gutter depth for both  $Q_1$  and  $Q_2$  is less than the ponding depth for both 5- and 10-foot length inlets; therefore, water will back up in the gutter on both sides of the inlet.

In addition to illustrating the use of the sag curves, Example 5 shows the necessity of picking up most of the gutter flow before it reaches the low point of the sag vertical curve. Spreads on the pavement ( $T$ ) and depths at the curb ( $d_{max}$ ) noted in step 2 could not be tolerated on a high speed highway. The more common application of the sag curves would be in designing curb-opening inlets or their spacing to keep the depth of ponding and spread on the pavement within tolerable limits.

#### 4.60 Combination Inlets

The capacity of an unclogged combination inlet on a continuous grade using an efficient grate, is not appreciably greater than that of the grate alone. Therefore, the capacity is computed by ignoring the curb-opening and computing the capacity of the grate opening alone.

Conner and Larson found that diagonal grating bars were superior to transverse bars on combination inlets. Neither investigation compared a diagonal bar grate with the hydraulically superior longitudinal bar grate of comparable size.

#### 4.70 Inlet Location

In general, inlets should be placed at all low points in the gutter grade and at intersections to prevent the gutter flow from crossing traffic lanes of the intersecting road. In urban locations, inlets are normally placed upgrade from pedestrian crossings to intercept the gutter flow before it reaches the crosswalk. Where pavement surfaces are warped, as at cross streets, ramps, or in transitions between superelevated and normal sections, gutter flow should be picked up before the cross slope of the pavement begins to change in order to lessen water flowing across the roadway and to prevent icing.

In a sag vertical curve, three inlets are desirable. On major streets and arterials three inlets should be used; one at the low point and one on each side of this point where the grade elevation is at least 0.2 feet higher than that at the low point. The additional inlets furnish added capacity to allow for flow bypassing the upgrade inlets and provide a safety factor if the sag inlet becomes clogged. These inlets limit the deposition of sediment on the road in the sag, and they also reduce flow arriving at the low point and thereby prevent ponding which would flood the road.

Where a curbed roadway crosses a bridge the gutter flow should be intercepted and not be permitted to flow onto the bridge.



## Spacing of Inlets on a Continuous Grade

Inlets should be spaced so as to limit the spread of the water on the pavement to the criterion outlined in Section 3.20.

With the maximum spread fixed and with a given pavement cross slope and longitudinal slope, the flow in the gutter is also fixed and can be calculated as explained in Section 3. The spacing of inlets is equal to the length of pavement needed to generate the discharge corresponding to the allowable spread on the pavement. The flow bypassing each inlet must be included in the flow arriving at the next inlet.

An example of the computations for inlet spacing will be given for a grate inlet (Example 6) and for a curb-opening inlet (Example 7).

### Example 6

#### Grate Inlets

**Given:** A high-type arterial 4-lane section with 2' curb-and-gutter section ( $n = 0.016$ ) (widths =  $4(12) + 2(2) = 52'$ ). The pavement cross slope,  $S_x = 0.02$  ft/ft, longitudinal slope,  $S_o = 0.02$ ; composite C for pavement and shoulder = 0.8. The contributing area is 100' to each side of the centerline.

**Find:** Inlet spacing of 2-foot-wide efficient grate.

**Solution:**

1. Spread on pavement,  $T = \frac{52}{2} - 12 = 14'$
2.  $Z = \frac{1}{S_x} = 50$ ,  $\frac{Z}{n} = 3,125$
3. Depths at curb,  $d = \frac{T}{Z} = \frac{14}{50} = 0.28$
4. Compute the theoretical capacity for  $d = 0.28$ ,  $\frac{Z}{n} = 3,125$   
and  $S_o = 0.02$ . From Figure 3-2,  $Q = 8.0$  cfs.
5. Calculate allowable gutter capacity. From Figure 3-3,  
 $Q = 8.0$  cfs  $\times .80 = 6.4$  cfs.
6. The flow intercepted by a 2-foot grate with efficient openings is computed as explained in Example 2.  
 $Q_i = 2.0$  cfs.
7. The length of roadway above the inlet should be sufficient to generate the gutter flow (6.4 cfs, step 5) corresponding to the

allowable spread. Use the rational method for successive lengths to determine this initial spacing.

$$Q = CiA$$

where:

$$Q = 6.4 \text{ cfs}$$

$$C = \text{composite for pavement and shoulder} = .60$$

$$V = 2.8 \text{ ft/sec from Figure 2-2}$$

$$T_c = 3.0 \text{ min for overland flow}$$

$$A = \frac{200 \times L}{43560}$$

Try  $L = 300'$

$$T_c = \frac{300'}{(2.8) 60} + 3.0 = 4.8 \text{ (Use 5 min)}$$

$$i = 7.8 \text{ in./hr from Figure 2-1}$$

$$A = \frac{300 \times 200}{43560} = 1.4 \text{ ac}$$

$$Q = CiA = (.60)(7.8)(1.4) = 6.5 \text{ cfs}$$

Use  $L = 300 \text{ ft}$  for first inlet.

8. The flow bypassing the grate appears at the next grate and only the flow intercepted (2.0 cfs) must be supplied by the area between grates.

$$A_2 = \frac{2.0}{(.8) 7.8} = .32 \text{ ac or } 13,960 \text{ sq ft}$$

$$L_2 = \frac{13,960}{200} = 70 \text{ ft}$$

### Example 7

#### Curb-Opening Inlets

Given: Conditions as in Example 6.

Find: Inlet length for 50% interception and spacing between inlets where  $w = 2.0 \text{ ft}$  and  $a = 2 \text{ inches}$

Solution:

1. Spread on pavement = 14'

2. Discharge in gutter, from Example 6,  $Q = 6.4$  cfs.
3. Length of roadway above first inlet = 300 feet (Step 7, Example 6).
4. Compute inlet size for 50% interception.
  - $d = 0.28'$
  - $n = 0.016$
  - $S_o = 0.20$
  - $T = 14'$
  - $Q_i/Q = .5$
  - $S_x = .02$

From Figure 4-7,  $L_i = 10'$

5. The flow intercepted by the inlet must be supplied by the intervening pavement if the design spread is obtained. The area of pavement need is:

$$\frac{3.20}{(.6)(7.8)} = .68 \text{ ac or } 29,785 \text{ sq ft}$$

The spacing of successive inlets after the upstream inlet,

$$L = \frac{29785}{200} = 149 \text{ feet. Use } 150 \text{ feet.}$$

### Spacing of Inlets in a Sag

Three inlets should be placed in a sag vertical curve on all major streets, one at the low point and one on each side of this point, where the grade elevation is approximately 0.2 feet higher than that at the low point. The inlets should be spaced so as to limit the spread of water on the pavement to the criterion outlined in Section 3.20.

As a result of these criteria, the inlets in a sag of an expressway must, at times, be designed to remove the stormwater resulting from a 50-year storm over the contributing area minus the flow intercepted by the inlets on the grade, which are designed to limit the spread of water from a 10-year storm to a tolerable limit. The inlets on the grade will intercept a greater quantity of water during the 50-year storm than the quantity (from a 10-year storm) used to determine their spacing, but the spread of water on the pavement will exceed the spread designated as the tolerable limit.

Because of the various combinations in which sag inlets are used, examples cannot be given to fit all problems encountered by the designer. Example 8 will illustrate the spacing of inlets in a sag which must be designed for a 50-year frequency when the inlets on the grade are spaced for a 10-year frequency. The problem of sag inlets designed for some other frequency can be solved with a slight modification of the procedure used in Example 8. The procedure can be used for other type inlets whose capacities are known.

### Example 8

#### Design of Curb-Opening Inlets in a Sag

**Given:** Grades, -3 percent and +3 percent, each 2,170 feet long, intersecting at station 50. A 600-foot vertical curve connects the tangents. Conditions are the same as in Examples 6 and 7. The inlets on the grades are 10-foot curb-opening inlets, designed to limit the spread on the pavement to 6 feet at the 10-year frequency. The gutter is 2-feet wide and the depression is 2-feet wide and 2-inches deep.

**Find:** Size and location of the 3 curb-opening inlets in the sag. The inlets will be designed to limit the spread on the pavement for a 50-year frequency storm to 6 feet.

**Solution:**

1. The grades are symmetrical about the P.I. of the vertical curve and only a half section need be considered. The first inlet (see Example 7) is located 830 feet from the crest and successive inlets are spaced at 520 foot intervals. The computations for peak flow arriving at the sag inlet at station 50 are given in Table 4-2.
2. The 10-foot curb openings are spaced (Column 3) for a 10-year frequency storm as explained in Example 7. An inlet, of width opening to be determined, is placed at the P.V.I. station 50 + 00. The inlet at station 49 + 40 is placed where the grade elevation is about 0.2 feet higher than the grade elevation at the P.V.I. A 10-foot curb opening is tentatively placed here and the computations shown in Table 4-2 are made to determine the width of opening required in the sag. If the sag inlet opening is excessive, wider openings can be used at the 0.2 feet higher elevation point. The spacing and width of opening on the grades might require adjustment in some instances.
3. The runoff between inlets (column 11) is computed by the rational method based on the 50-year rainfall intensity (Column 10) during the accumulated time of concentration (Column 9). Column 12 is the  $Q$  arriving at the inlet and consists of the  $Q_c$  (Column 17) bypassing the last inlet plus the  $Q$  (Column 11) from the area between inlets. On the grade, the spread on the pavement,  $T$  (Column 14) exceeds the allowable spread, 8 feet, which was based on a 10-year rainfall intensity.
4. The discharge arriving at the sag inlet from both sides is 4.82 cfs (Column 12). From Figure 4-9, this  $Q$  would require the following height of opening;  $L_i = 15$  feet,  $h_m = 0.16$  feet;  $L_i = 10$  feet,  $h_m = 0.23$  feet;  $L_i = 5$  feet,  $h_m = 0.34$  feet.

Table 4-2 Computations for Sag Inlets

1	2	3	4	5	6	7	8	9	10	11	12	13	14	15	16	17
Inlet Station	Elev. (ft.)	Dist. (ft.)	Grade (%)	$\Delta A$ (acres)	C	$\Delta CA$	$\Delta T_c$ (min.)	$\Sigma T_c$ (min.)	i 50-yr.	$\Delta Q$ (cfs)	Q (cfs)	d (ft.)	T (ft.)	Q1/Q	Q1 (cfs)	Qc (cfs)
36 + 60	140.20	830	3.0	0.50	0.8	0.40	5	5	14.7	5.88	5.88	0.27	9.0	0.52	3.05	2.83
41 + 80	124.60	520	3.0	0.31	0.8	0.25	0.7	5.7	14.2	3.55	6.38	0.28	9.3	0.50	3.19	3.19
P.V.C. 47 + 00	109.00	520	3.0	0.31	0.8	0.25	0.7	6.4	13.8	3.45	6.64	0.28	9.3	0.50	3.32	3.32
49 + 40	104.69	240	1.8	0.14	0.8	0.11	0.5	6.9	13.4	1.47	4.79	0.25	8.3	0.58	2.78	2.01
P.V.I. 50 + 00	104.50	60	0.3	0.04	0.8	0.03	0.2	7.1	13.3	0.40	2.41					
									Total at sta. 50 + 00		4.82	0.20	6.7	1.0	4.82	0

5. The depth at the curb for an allowable spread of 6 feet on the traveled way is 0.24 feet. On Figure 4-10 for  $w = 2$  feet,  $a = 2$  inches, and  $Q = 4.82$  cfs, a 10-foot opening will carry the flow with a depth of ponding in the gutter ( $d_{max}$ ) = 0.25 feet. A 15-foot opening will carry the flow with a depth of ponding = 0.20 feet. The ponding with the 15-foot opening is less than the allowable (0.24 ft) and the 15-foot opening with a clear height of at least 0.16 ft (Step 4) is satisfactory.

#### 4.80 Definition of Symbols for Sections 3 and 4

Symbol	Units	Description
A	sq ft	Area of cross section
A	ac	Drainage area tributary to the point under design
a	in.	Depression of inlet lip below the extension of gutter flow line
C		Runoff coefficient in the rational formula
d or y	ft	Depth of gutter flow at the curb line
$d_b$	ft	Depth of grate bars
$d_j$	ft	Depth of water above inlet lip
$F_w$		Froude Number based on depths and velocity of uniform gutter flow at distance W from curb face
g	ft/sec <sup>2</sup>	Acceleration of gravity = 32.2
h	ft	Height of curb-opening inlet
$h_m$	ft	Minimum height of curb-opening inlet for free fall into inlet
i	in./hr	Average rainfall intensity during the time of concentration
L	ft	Length of roadway between inlets
$L_b$	ft	Length of clear opening of grate bars (see Section 4.5)
$L_j$	ft	Length of curb-opening inlet
$L_1$	ft	Length of inlet when $Q_j/Q = 1$ on first section of curve for $Q_j/Q =$ function $L_j/(F_w T)$
$L_2$	ft	Length of inlet at point of intersection of first and second sections of $Q_j/Q =$ function $L_j/(F_w T)$
$L_3$	ft	Length of inlet when $Q_j/Q = 1$ on second section of $Q_j/Q =$ function $L_j/(F_w T)$
n		Roughness coefficient in the modified Manning formula for triangular gutter flow
P	ft	Perimeter of grate opening, neglecting bars and side against curb
Q	cfs	Rate of discharge in gutter
$Q_c$	cfs	Rate of discharge bypassing the inlet (carry-over)
$Q_i$	cfs	Rate of discharge intercepted by inlet or total flow for sump inlets
$Q_2$	cfs	Value of $Q_j$ at $L_2$
$Q_i/Q$		Interception rate of curb-opening inlet (also called efficiency of inlet)

$S_0$	ft/ft	Longitudinal slope of pavement
$S_x$	ft/ft	Cross slope of pavement
T	ft	Top width of water surface (spread on pavement)
$T_c$	min	Time of concentration of a watershed
V	ft/sec	Mean velocity of flow
W	ft	Width of depression for curb-opening inlets
X	ft	Distance from curb face in gutter flow computations
Z		$\frac{1}{S_x}$ , reciprocal of the cross slope

The following figures give the capacity of depressed curb-opening inlets for the range of conditions listed in Table 4-3. Instructions for using these figures with examples are given in the above section.

The capacity charts were developed for gutters with a roughness coefficient,  $n = 0.016$ , but they can be used with sufficient accuracy, for gutters with "n" values from 0.012 to 0.016. Figure 4-7 was developed with "n" values from 0.010 to 0.016.

Table 4-3

Limiting Conditions of Design Figures

	<u>General Curves</u>	<u>Sump Curves</u>		
W, in ft	2	1	2	3
a, in in.	2	1	2	3
$S_0$	0.004 - 0.15		0	
$S_x$	0.015 - 1.0		0.015 - 0.06	
$L_i$ , in ft	1 - 200		5, 10, 15	
T, in ft	4 - 10		---	
Minimum Width from Curb to Crown of Roadway	--	12'	12'	18'
$d_{max}$	--	1'	1'	1'

where:

- W = width of depression;
- a = depression of inlet lip below the extension of gutter flow line;
- $S_0$  = longitudinal slope of pavement;
- $S_x$  = cross slope of pavement;
- $L_i$  = length of curb-opening inlet;
- T = top width of water surface (spread on pavement); and
- $d_{max}$  = maximum depth of ponding, curb-opening in sump.

#### 4.90 Bibliography

1. Bauer, W.J., and Woo, D.C., Hydraulic Design of Depressed Curb-Opening Inlets, Highway Research Board Record No. 58, Washington, DC, 1964, p. 61-80.
2. Federal Highway Administration, Drainage of Highway Pavements, Hydraulic Engineering Circular No. 12, Washington, DC, 1969.
3. Izzard, Carl. F., Simplified Method For Design of Curb-Opening Inlets, Report presented at the Annual Meeting of the National Transportation Board, January 1977.
4. Karaki, S.S., and Haynie, R.M., Depressed Curb-Opening Inlets-- Experimental Data, Colorado State University, Civil Engineering Section, Fort Collins, CO, 1961, CER61SSK34.



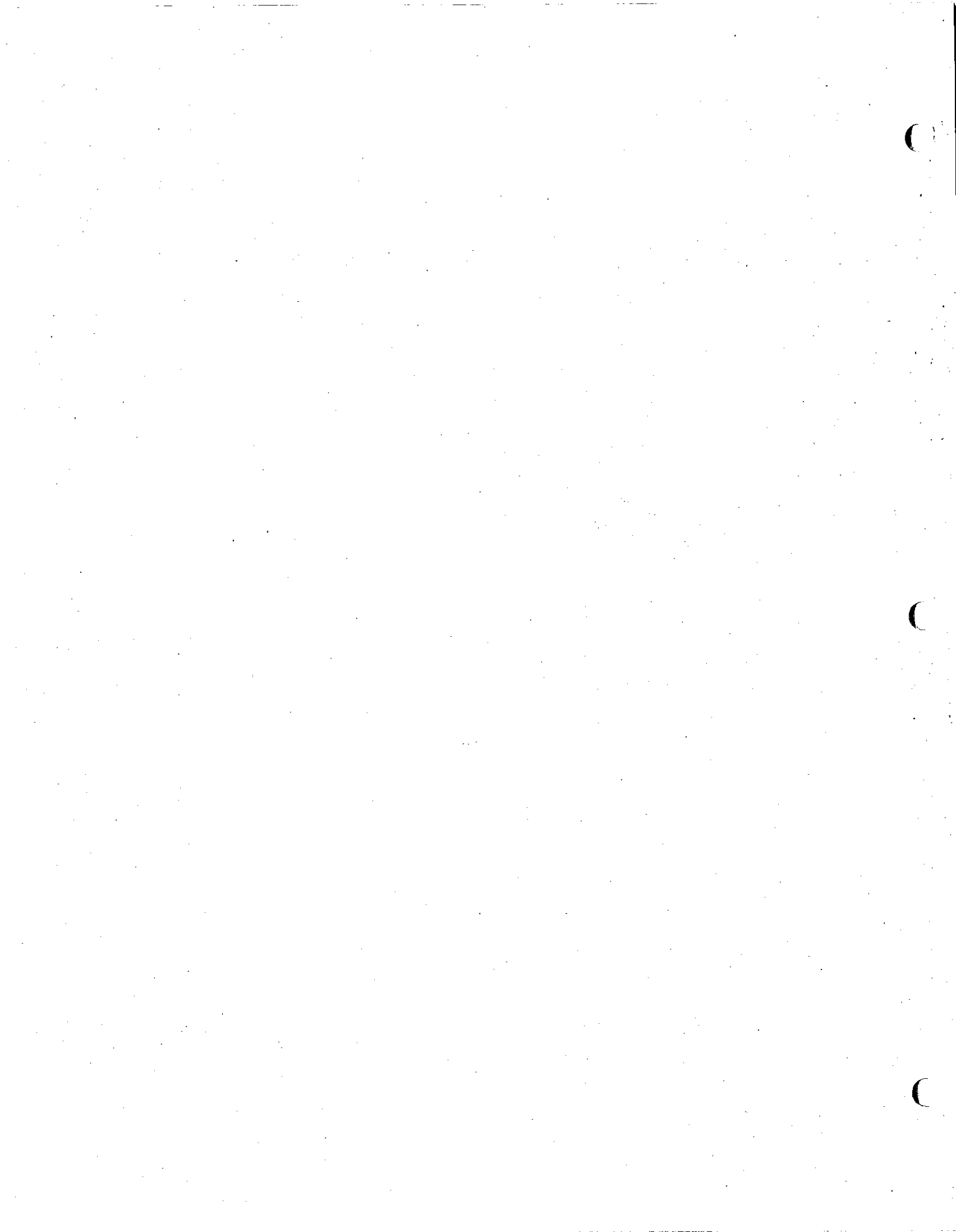

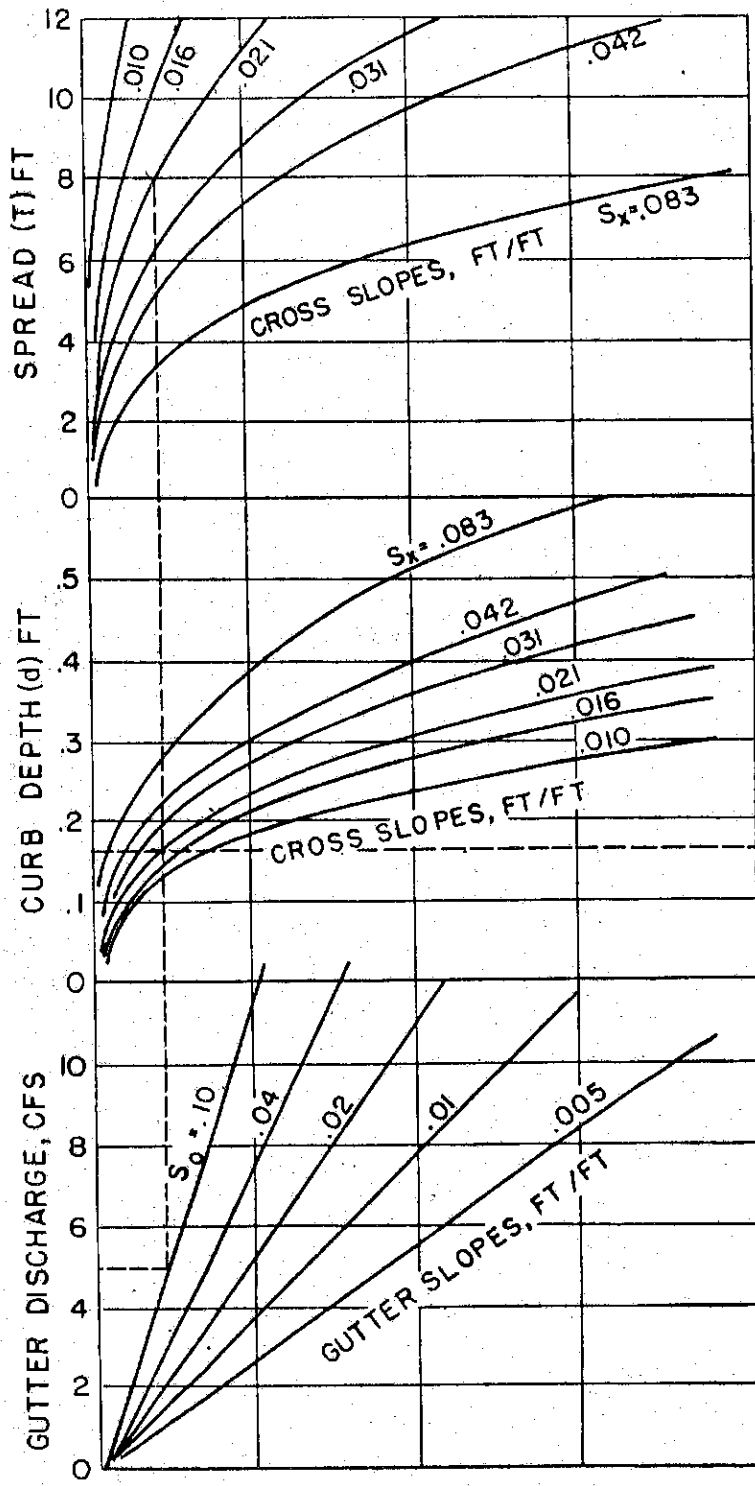

EXAMPLE (SEE DASHED LINES)

GIVEN:  
 $T = 8.0 \text{ FT}$   
 $S_x = 0.021$   
 $S_o = 0.10$

FIND:  
 $Q = 5.0 \text{ CFS}$   
 $d = 0.17 \text{ FT}$   
 $L_b \text{ FOR EFFICIENT GRATE}$   
 $= 3.0 \text{ FT}$

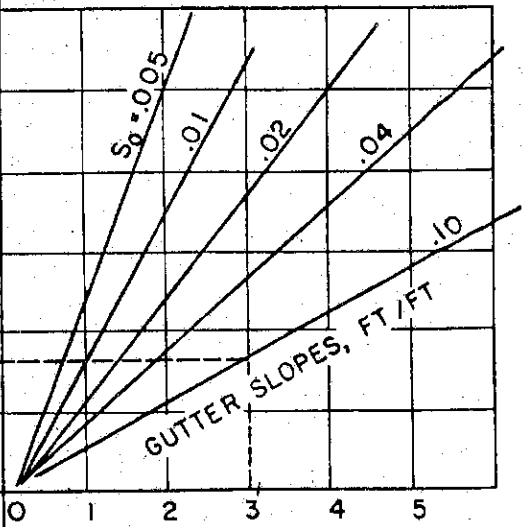

LENGTH OF CLEAR OPENING OF GRATE BAR,  $L_b$ , IN FT, FOR EFFICIENT GRATE

$n = 0.015$                        $d_b = 3 \frac{1}{2} \text{ in.}$   
 For other n's use  $Q_c = \frac{Q_n (0.015)}{n_c}$

Figure 4-3 Flow-Characteristics Curves for Gate Inlets

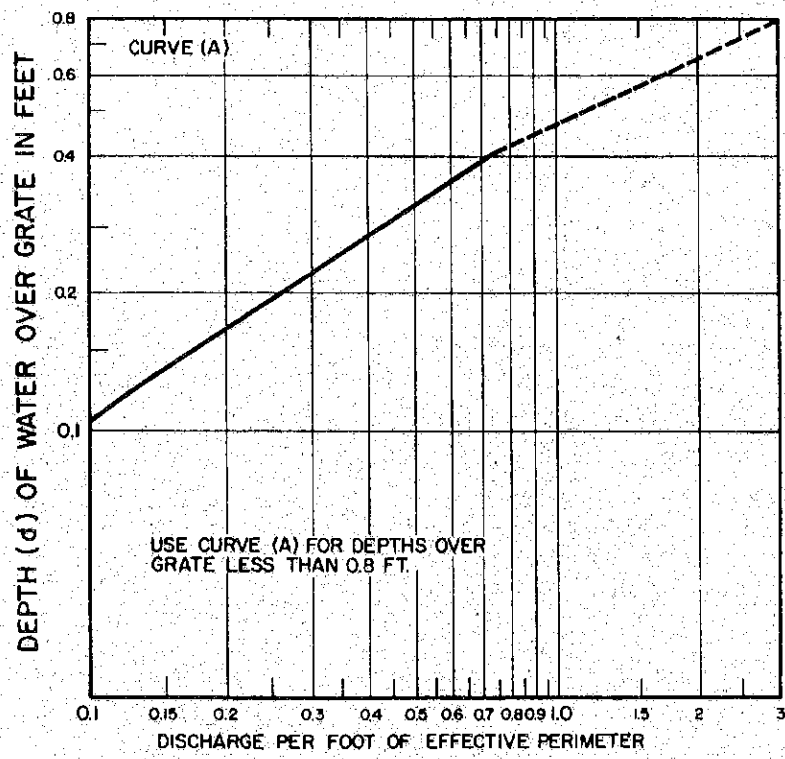
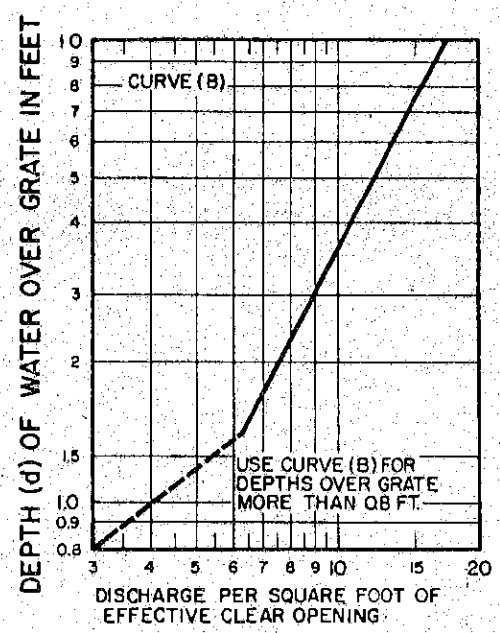
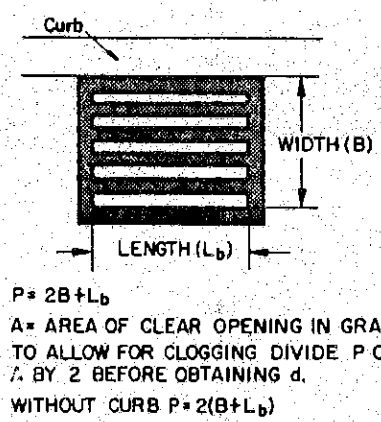

BUREAU OF PUBLIC ROADS  
 REV. AUG. 1968

Figure 4-4 Hydraulic Capacity of Grate Inlet in Sump

$$S_x (T-2) = d_w$$

0.03 0.04 0.06 0.08 0.1 0.15 0.2 0.3 0.4 0.6 0.8 1.0

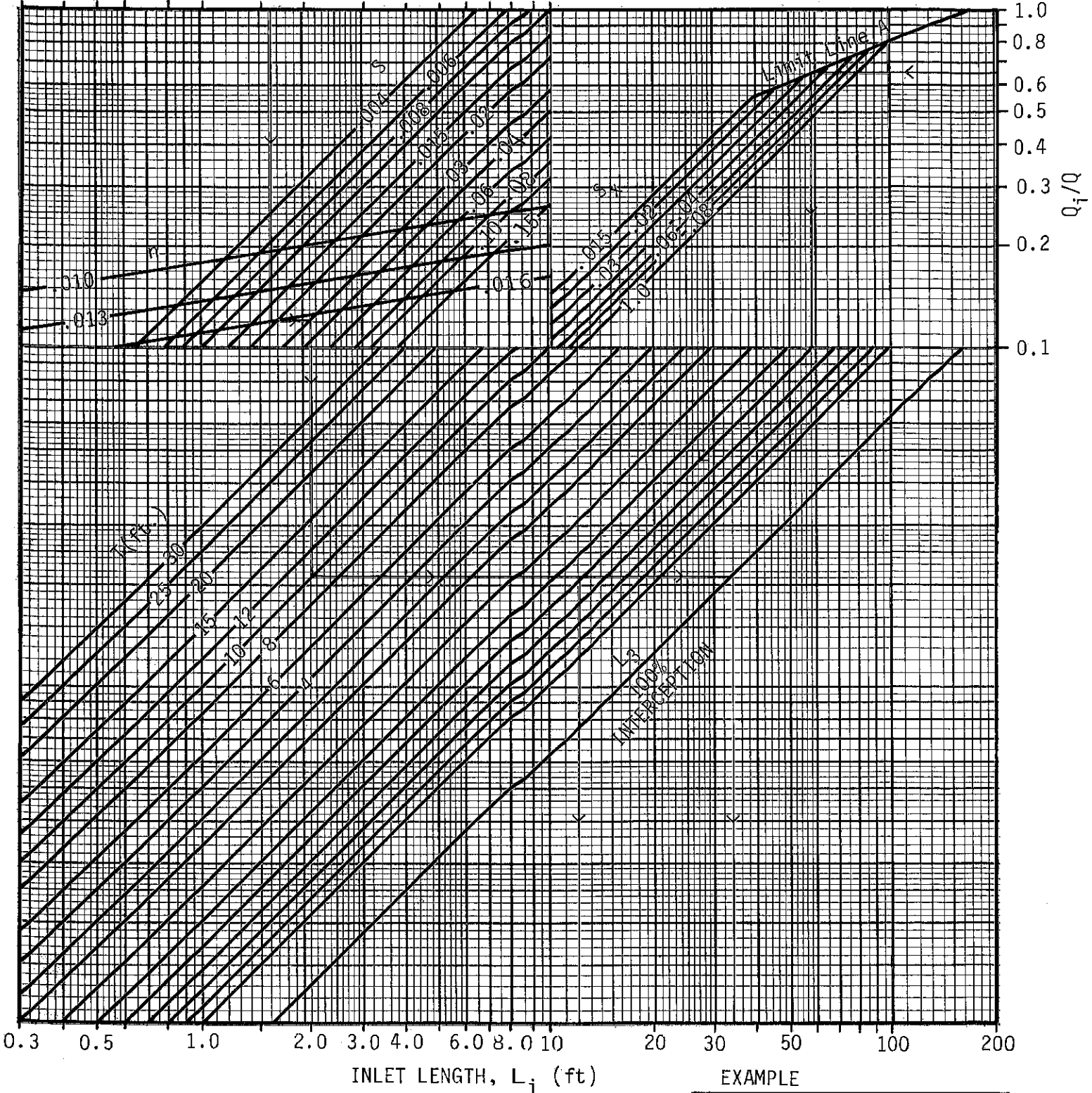

This chart assumes,  $w=2$  ft,  $a=2$ " and  $h=6$ in.

EXAMPLE	
Given	$S_x = 0.02$ ft/ft
	$T = 10$ ft
	$S = 0.03$ ft/ft
Find	$L_i = 11.8$ ft $L_i = 34$ ft
	$Q_i/Q = 0.65$ $Q_i/Q = 1.0$

Figure 4-7 Standard Curb-Opening Inlet Chart



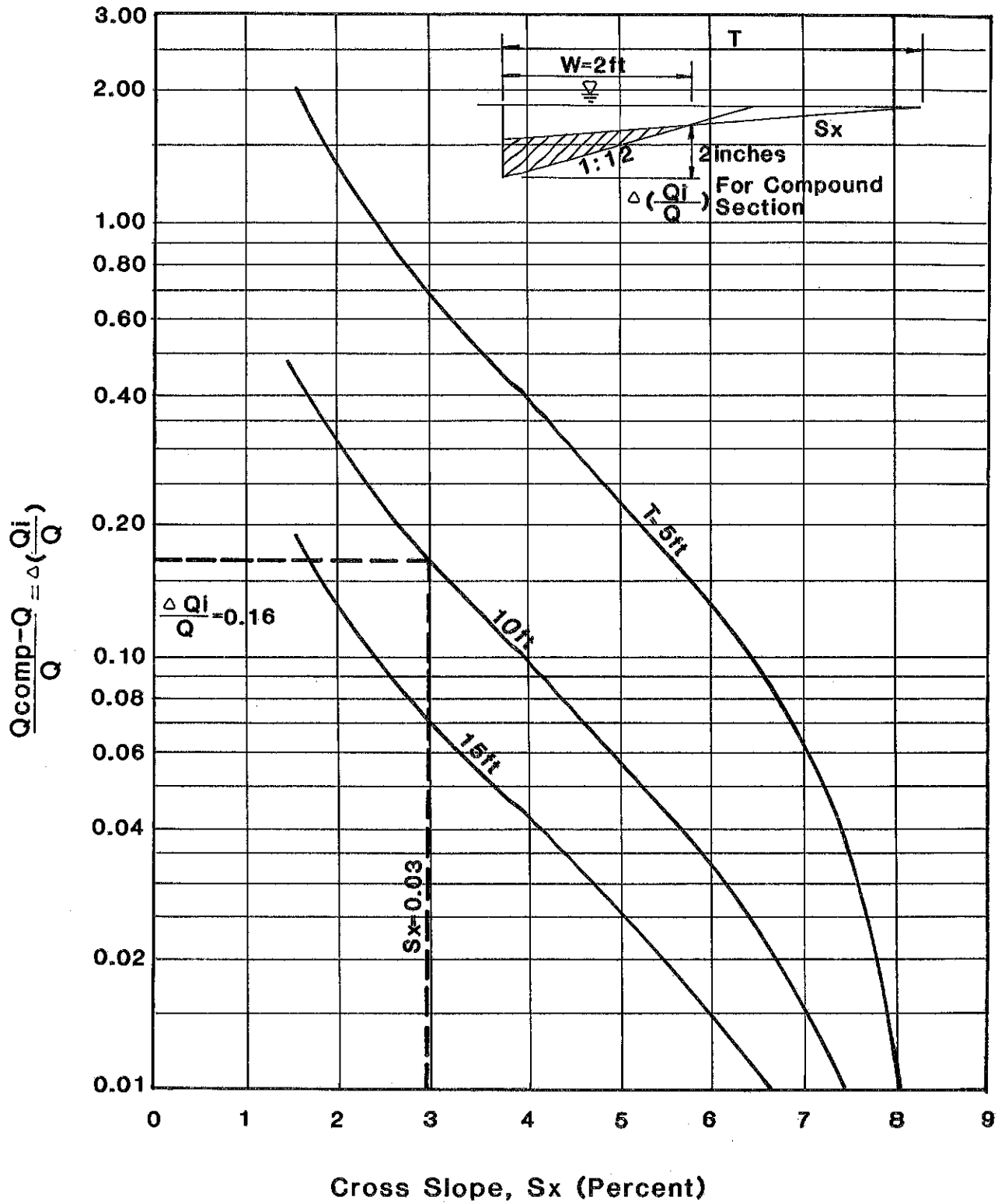

Figure 4-8 Additional Inlet Flow Due to Compound Section



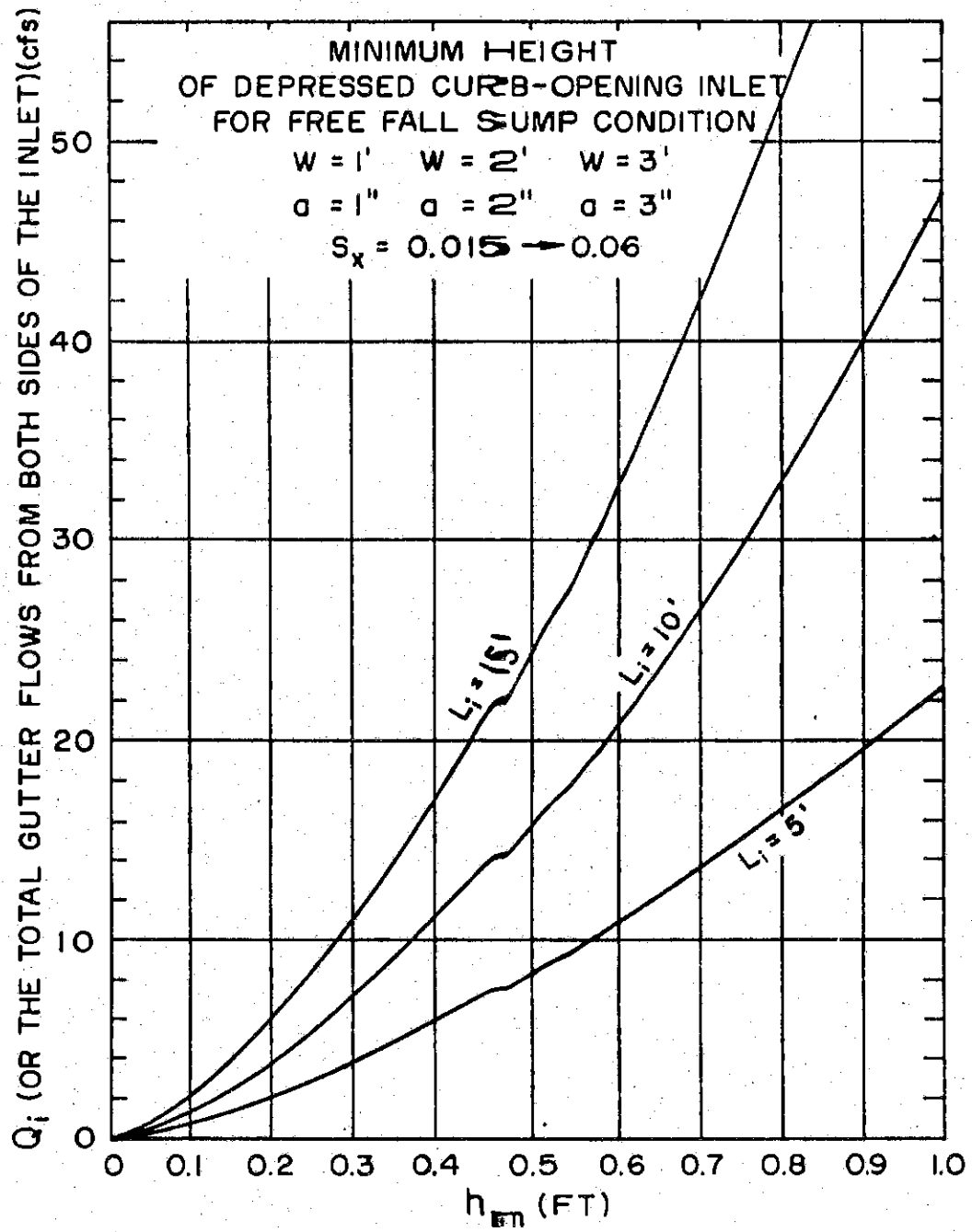

Figure 4-9 Sump Capacity for Curb-Opening Inlets



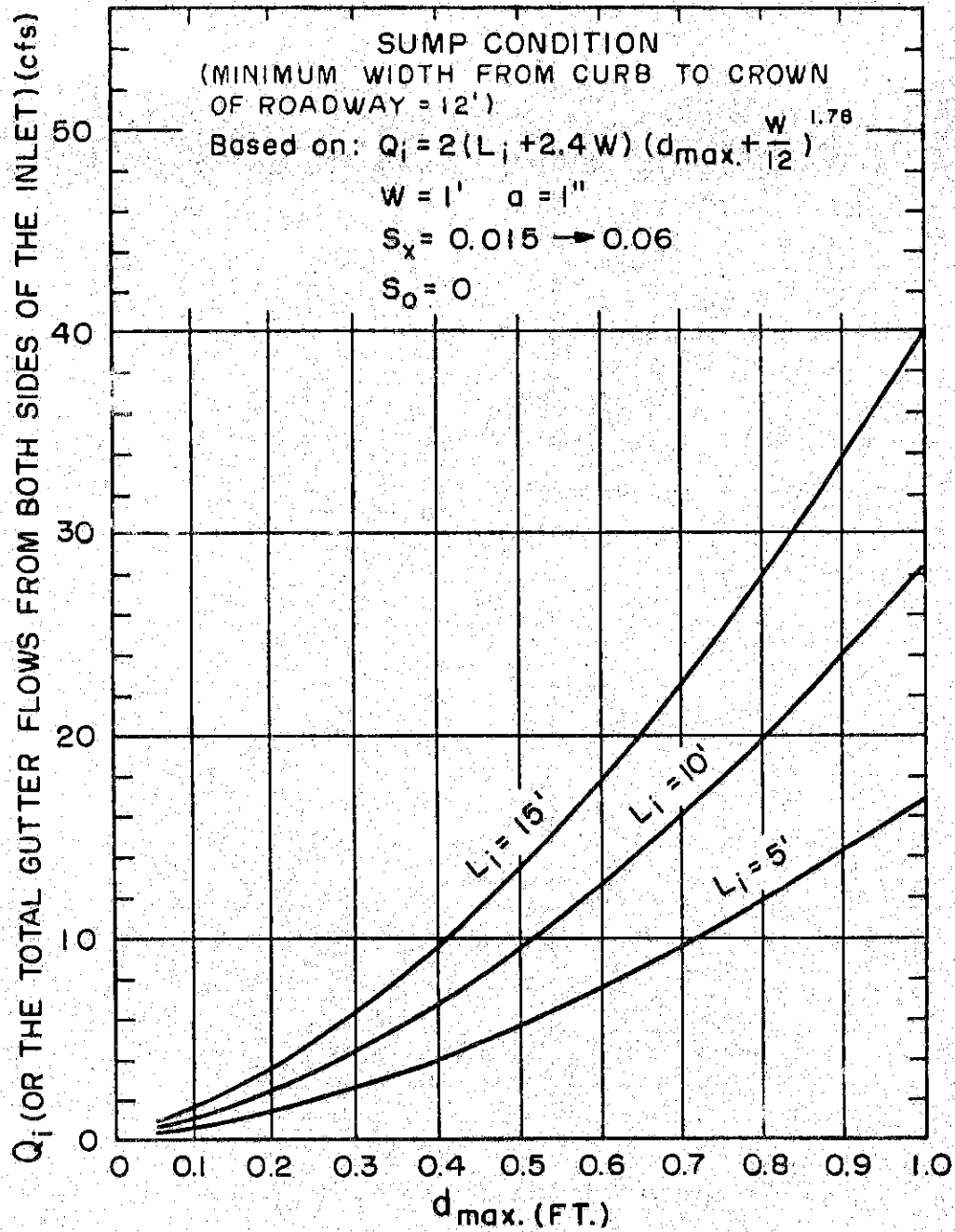

Figure 4-10 Sump Capacity for Curb-Opening Inlets.

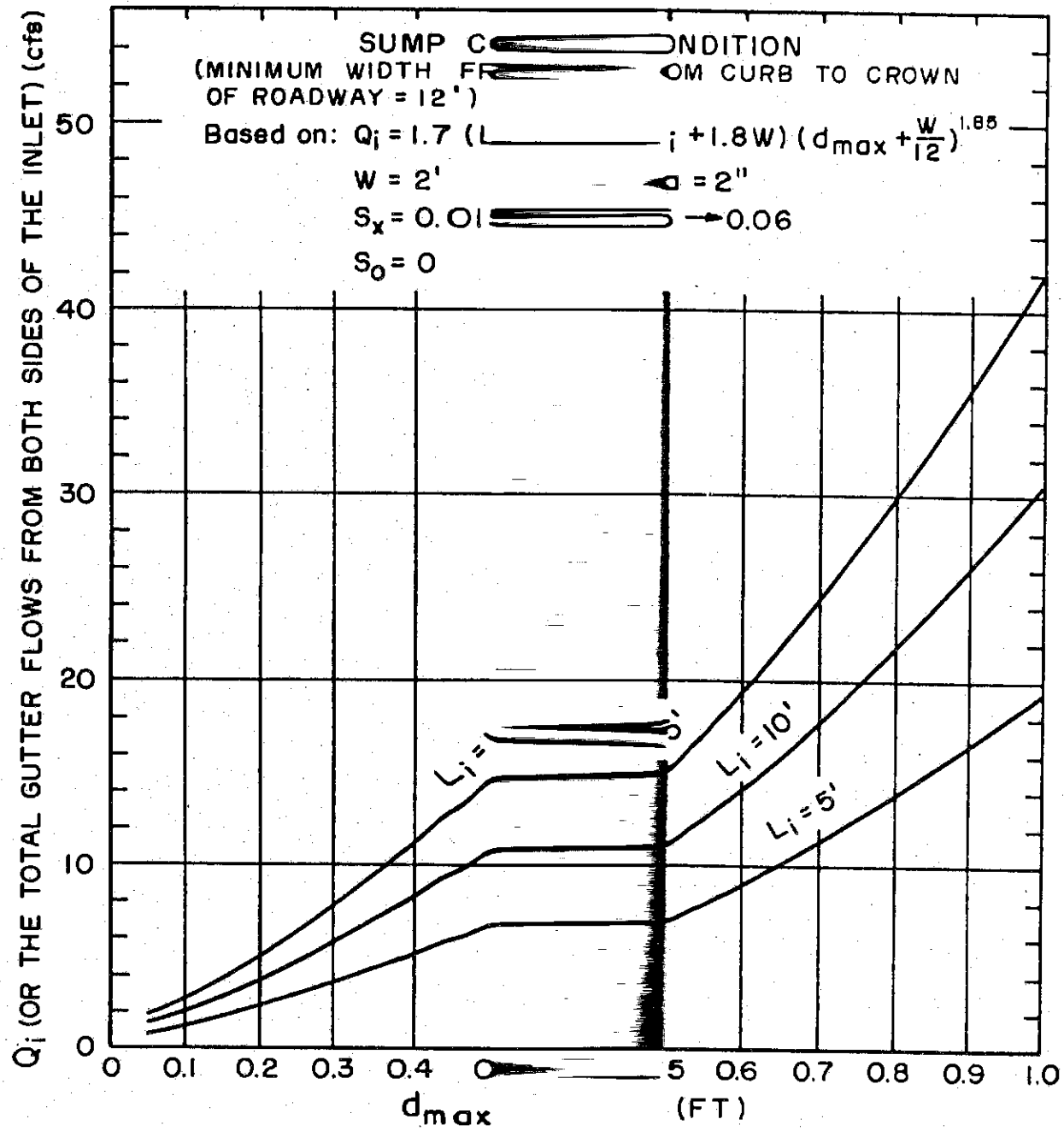

Figure 4-11 Sump Capacity for Curb-Opening Inlets

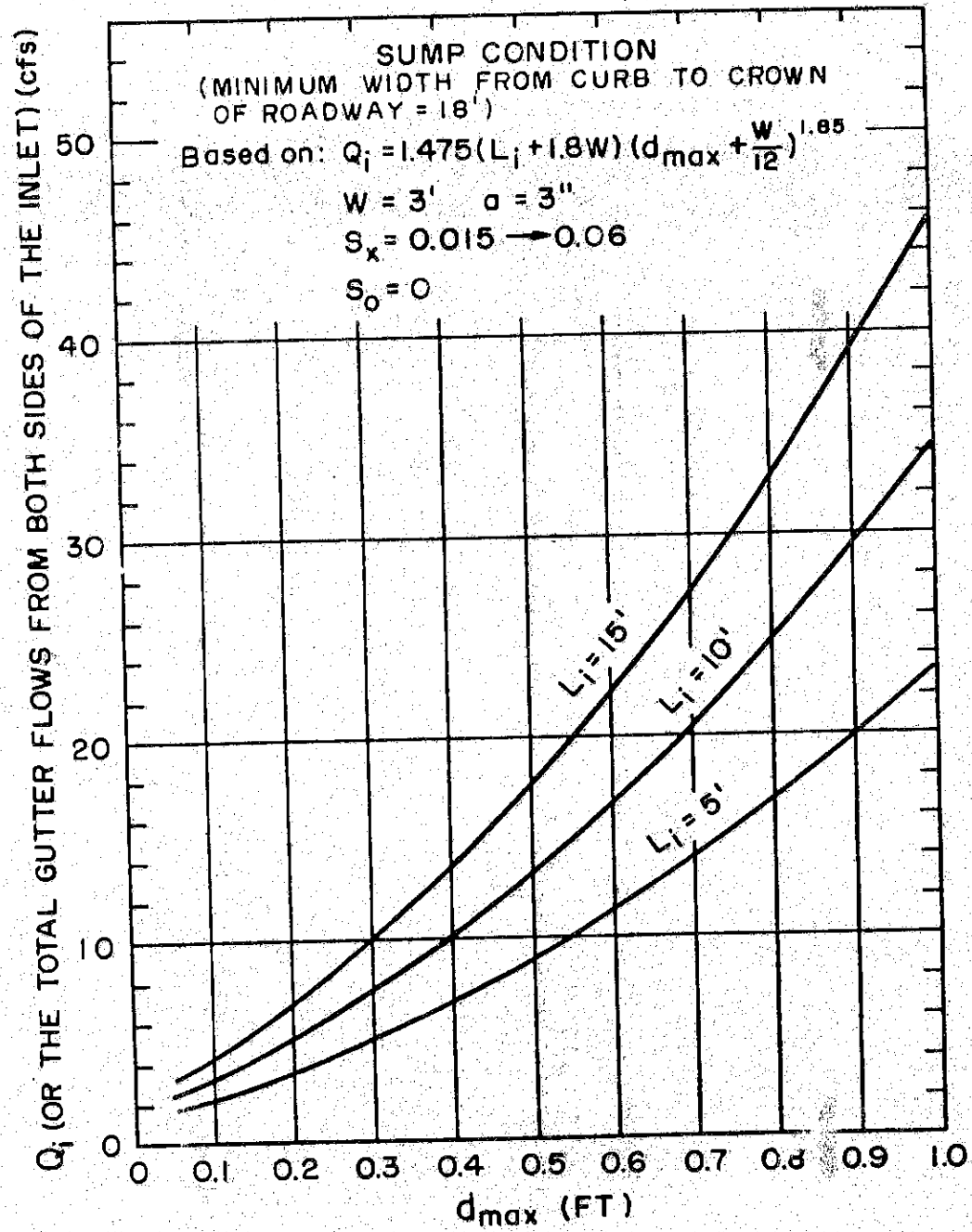

Figure 4-12 Sump Capacity for Curb-Opening Inlets

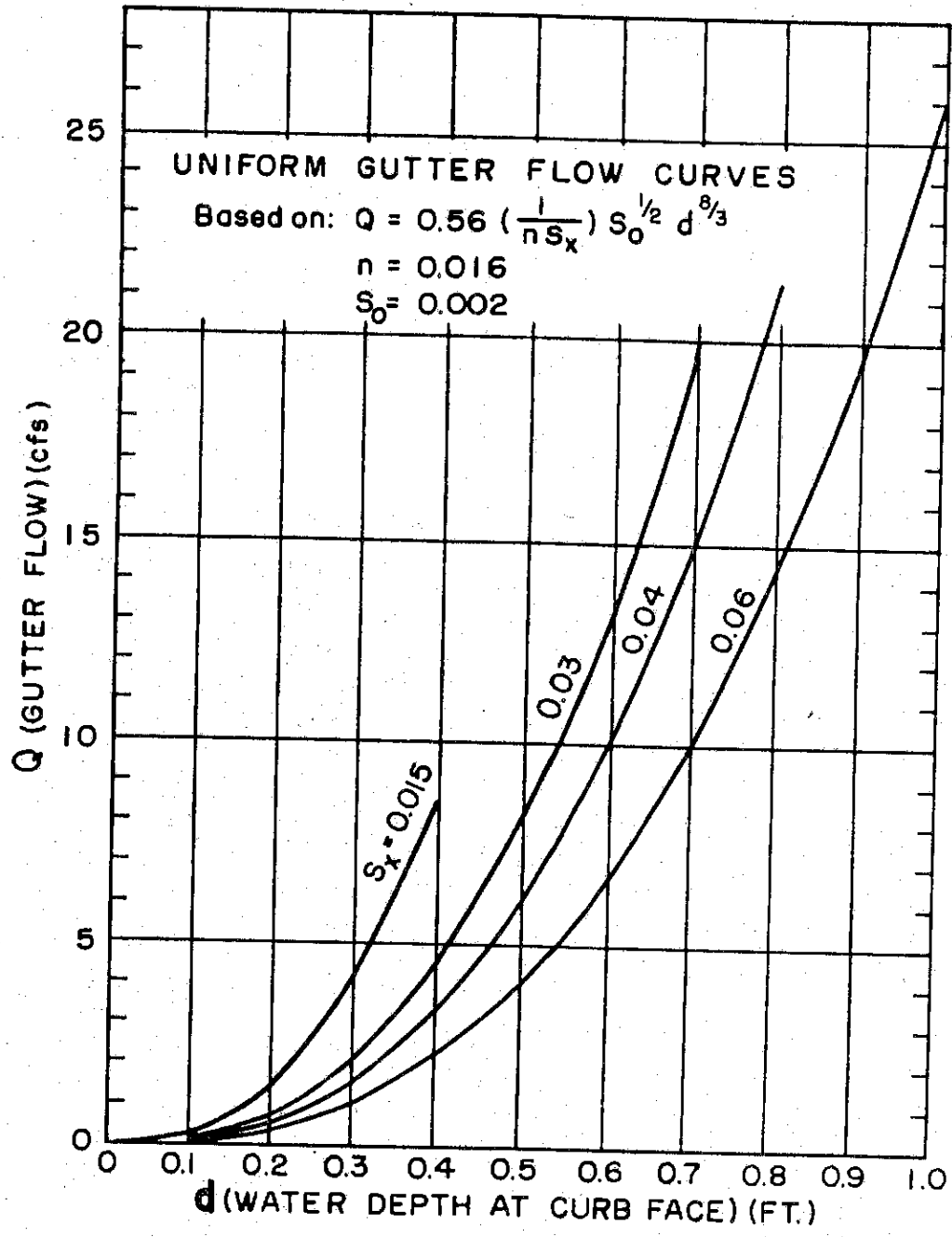
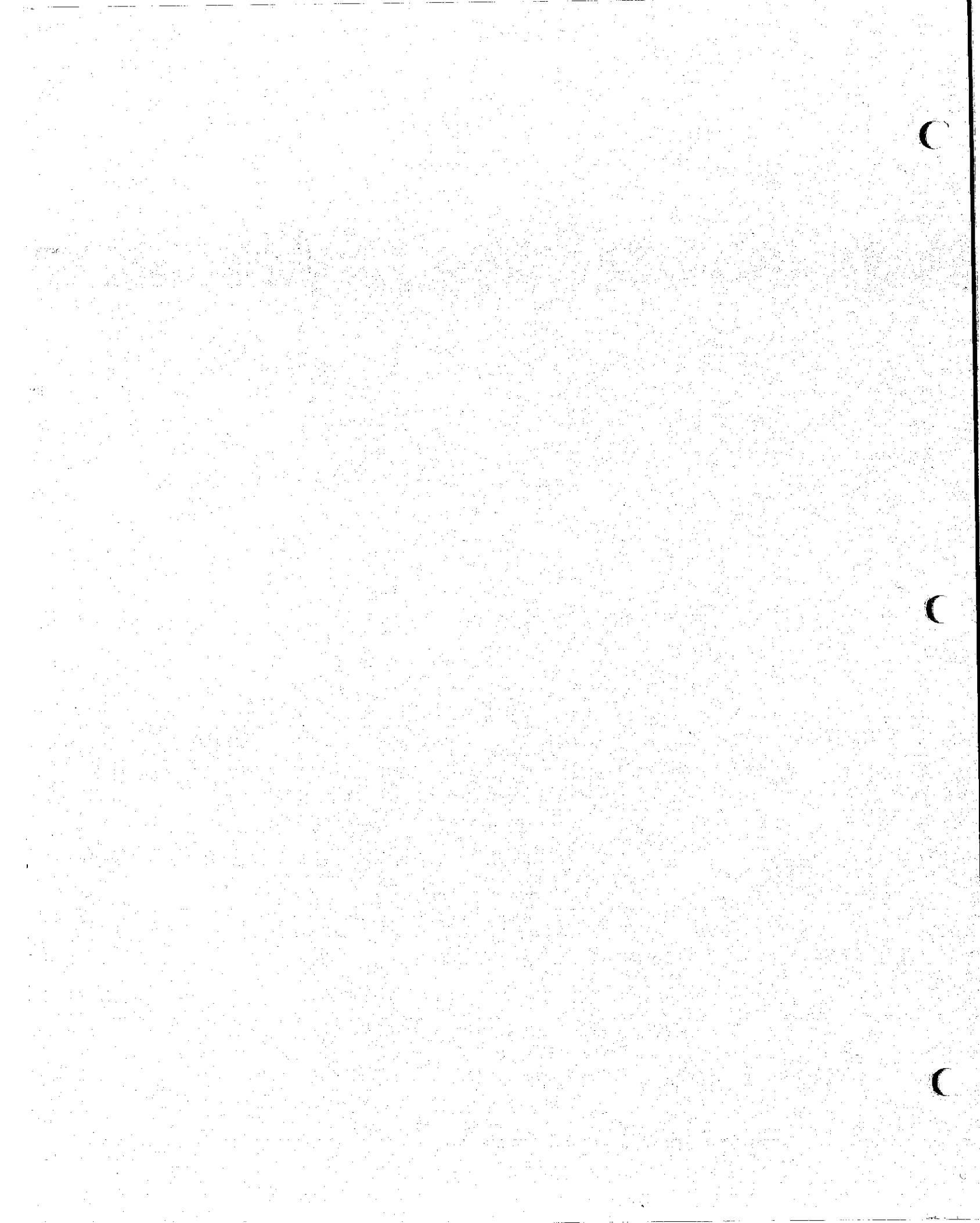

Figure 4-13 Uniform Gutter Flow Curves



## Section 5

### Storm Sewers and Appurtenances

- 5.10 General Criteria
  - Frequency of Design Runoff
  - Velocities and Grades
  - Materials
  - Manhole Location
  - Pipe Connections
  - Utilities
- 5.20 Flow in Storm Sewers
  - Pipe Flow Charts
- 5.30 Hydraulic Gradient and Profiles of Storm Sewers
  - Total Energy Losses at Structures
  - Minor Head Losses at Structures
    - Obstructions
    - Expansions and Contractions
- 5.40 Design Procedure for Storm Sewer Systems
  - Preliminary Design Considerations
  - Inlet System
  - Storm Sewer System
- 5.50 Bibliography

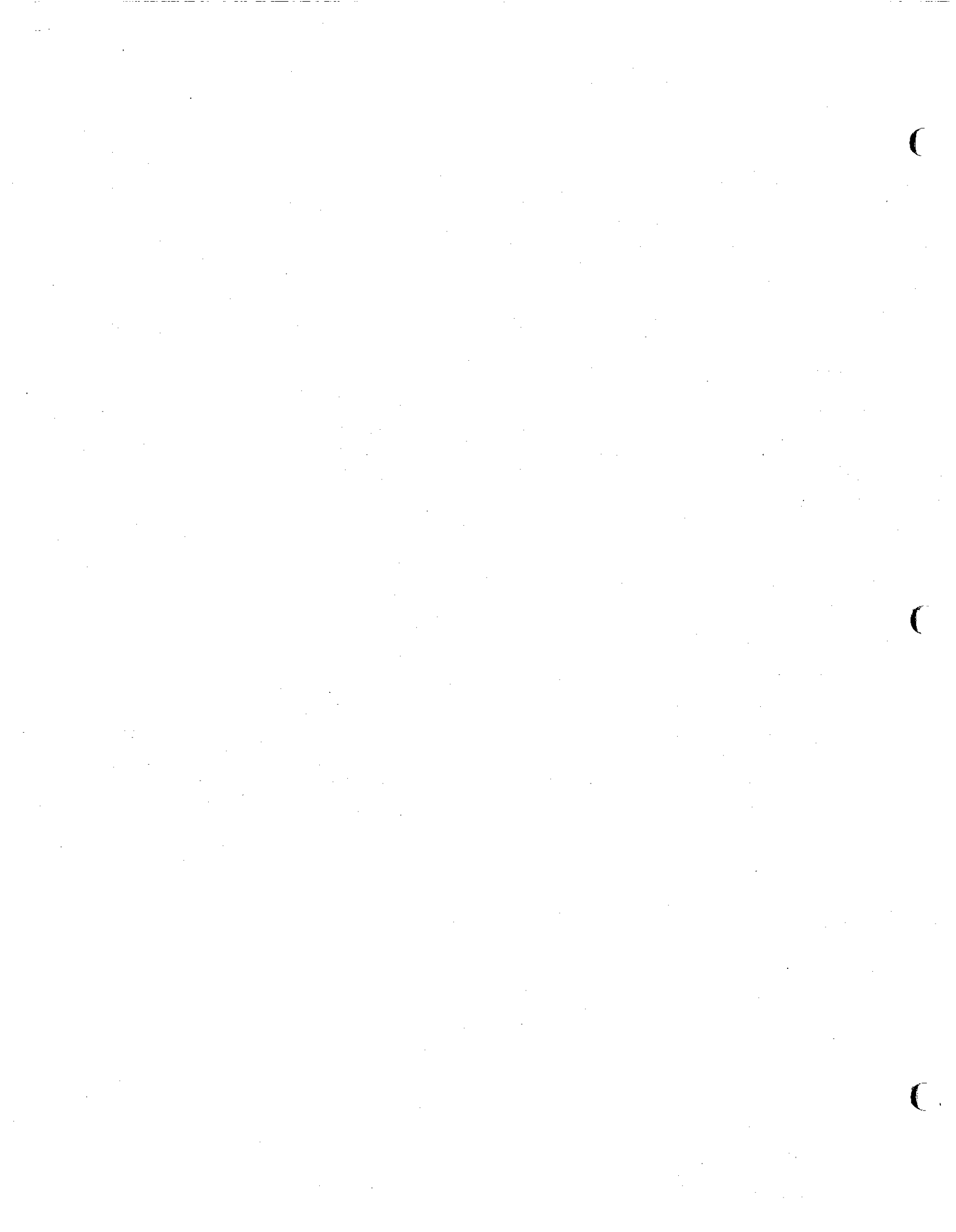

## Section 5

### Storm Sewers and Appurtenances

It is the purpose of this section to consider the significance of the hydraulic elements of storm sewers and their appurtenances to a storm drainage system. Hydraulically, storm drainage systems are conduits (open or enclosed) in which unsteady and non-uniform free flow exists. Storm sewers accordingly are designed for open-channel flow to satisfy as well as make possible the requirements for unsteady and non-uniform flow. Steady flow conditions may or may not be uniform.

All storm sewers shall be designed by the application of the Manning Equation either directly or through appropriate charts or nomographs. In the preparation of hydraulic designs, a thorough investigation shall be made of all existing structures and their performance on the waterway in question.

The design of a storm drainage system should be governed by the following six conditions:

1. The system must accommodate the initial surface runoff resulting from the selected design storm without serious damage to physical facilities or substantial interruption of normal traffic.
2. Runoff resulting from major storms exceeding the design storm must be anticipated and discharged with minimum damage to physical facilities and minimum interruption of normal traffic.
3. The storm drainage system must have a maximum reliability of operation.
4. The construction costs of the system must be reasonable with relationship to the importance of the facilities it protects.
5. The storm drainage system must require minimum maintenance and must be accessible for maintenance operations.
6. The storm drainage system must be adaptable to future expansion with minimum additional cost by the consideration of ultimate development on upstream or existing reaches.

#### 5.10 General Criteria

##### Frequency of Design Runoff

The frequency of design runoff is a function of operational and economic criteria with a special emphasis on public safety. As discussed in other sections of this Manual some types of facilities do not require high levels of protection and periodic flooding is not objectionable. However, for all facilities the designer must consider



the impact of a 100-year flood and provide for its passage without the loss of life or major property damage.

Table 5-1 indicates the minimum acceptable frequencies of design runoff for storm sewers.

Table 5-1

Storm Sewer Design Storm Frequency

<u>Facility</u>	<u>Storm Return Period (Frequency)</u>
Streets and Gutters	10 years*
Inlets	10 years*
Storm Sewers	10 years
Major Drainage System	100 years

\* See Table 3-2 for Special Criteria for arterial streets and freeways.

Velocities and Grades

Minimum Grades

Storm sewers should operate with velocities of flow sufficient to prevent excessive deposition of solid material; otherwise, objectionable clogging may result. The controlling velocity occurs near the bottom of the conduit and is considerably less than the mean velocity. Storm sewers shall be designed to have a minimum mean velocity flowing full of 2.5 fps. Table 5-2 indicates the grades for both concrete pipe ( $n = 0.013$ ) and for corrugated metal pipe ( $n = 0.024$ ) to produce a velocity of 2.5 fps, which is considered to be the lower limit of scouring velocity. Any variance must be approved by the appropriate agency. Outlets on sewers of minimum grade should be designed to avoid sedimentation at the outfall.

Table 5-2

Minimum Slope Required For Scouring Velocity

<u>Pipe Size (inches)</u>	<u>Concrete Pipe Slope (ft/ft)</u>	<u>Corrugated Metal Pipe Slope (ft/ft)</u>
18	0.0018	0.0060
21	0.0015	0.0049
24	0.0013	0.0041
27	0.0011	0.0035
30	0.0009	0.0031
36	0.0007	0.0024
42	0.0006	0.0020
48	0.0005	0.0016
54	0.0004	0.0014
60	0.0004	0.0012
66	0.0004	0.0011
72	0.0003	0.0010
78	0.0003	0.0009
84	0.0003	0.0008
96	0.0002	0.0007

Maximum Velocities

Maximum velocities in conduits are important mainly because of the possibilities of excessive erosion on the storm drain inverts. Table 5-3 shows the limits of maximum velocity.

Table 5-3

Maximum Velocity in Storm Sewers

<u>Description</u>	<u>Maximum Permissible Velocity</u>
Culverts (all types)	15 fps
Storm Sewers (inlet laterals)	No Limit
Storm Sewers (collectors)	15 fps
Storm Sewers (mains)	12 fps

Minimum Diameter

Pipes which are to become an integral part of the public storm sewer system shall have a minimum diameter of 18 inches. If smaller diameters are required for utility clearance or special conditions contact the appropriate agency for approval.

## Materials

In selecting a roughness coefficient consideration shall be given to the average conditions during the useful life of the structure. An increased "n" value shall be used primarily in analyzing old conduits where alignment is poor and joints have become rough. If, for example, concrete pipe is being designed at a location and there is reason to believe that the roughness would increase through erosion or corrosion of the interior surface, slight displacement of joints, or entrance of foreign materials, a roughness coefficient should be selected which, in the judgment of the designer, will represent the average condition. Any selection of "n" values below the minimum or above the maximum, either for monolithic concrete structures, concrete pipe, or corrugated metal pipe, must have the written approval of the appropriate agency.

The coefficients of roughness listed in Table 5-4 are for use in the nomographs contained herein, or for direct solution of Manning's Equation.

Table 5-4

### Roughness Coefficients "n" for Storm Sewers

<u>Materials of Construction</u>	<u>Design Coefficient<sup>1</sup></u>					
Concrete Pipe	0.013					
Corrugated-Metal Pipe*	2-2/3"x1/2" Corr.		3"x1" Corr.			
Unpaved	0.024		0.027			
25% Paved	0.021		0.023			
Structural Plate Pipe*	5 ft	7 ft	10 ft	15 ft		
Unpaved	0.033	0.032	0.030	0.028		
25% Paved	0.028	0.027	0.026	0.024		
Helically Corrugated Pipe*	2-2/3" x 1/2" corrugations					
	12"	18"	24"	36"	48"	
Unpaved	0.011	0.014	0.016	0.019	0.020	
25% Paved	--	--	0.015	0.017	0.020	
	3" x 1" corrugations					
	36"	48"	54"	60"	66"	72"
Unpaved	0.021	0.023	0.023	0.024	0.025	0.026
25% Paved	0.019	0.020	0.020	0.021	0.022	0.022
* Fully Paved All Types	0.012					

<sup>1</sup> Designer may select a single representative "n" for design purposes.

## Manhole Location

Manholes shall be located at intervals not to exceed 450 feet for pipe 30 inches in diameter or smaller. Manholes shall be located at conduit junctions, changes in grade, or changes in alignment.

Manholes for pipe greater than 30 inches in diameter shall be located at points where design indicates entrance into the conduit is desirable; however, in no case shall the distance between openings or entrances be greater than 600 feet.

## Pipe Connections

Prefabricated wye and tee connections are recommended up to and including 24" x 24". Connections larger than 24 inches will be made by field connections. This recommendation is based primarily on the fact that field connections are more easily fitted to a given alignment than are precast connections. Regardless of the amount of care exercised by the Contractor in laying the pipe, gain in footage invariably throws precast connections slightly out of alignment. This error increases in magnitude as the size of pipe increases.

## Utilities

In the design of a storm drainage system, the engineer is frequently confronted with the problem of grade conflict between the proposed Storm Drain and existing utilities such as water, gas, telephone, electrical, and sanitary sewer lines. When conflicts arise between a proposed drainage system and a utility system, the owner of the utility system should be contacted.

### 5.20 Flow in Storm Sewers

All storm drains shall be designed by the application of the continuity equation and Manning's Equation either through the appropriate charts and nomographs or by direct solutions of the equations as follows:

$$Q = AV; \text{ and} \quad (\text{Continuity}) \quad (5-1)$$

$$Q = \frac{1.49}{n} AR^{2/3} S_f^{1/2} \quad (\text{Manning's}) \quad (5-2)$$

where:

Q = pipe flow in cfs;

A = cross-sectional area of pipe, in square feet;

V = velocity of flow, in feet per second;

n = coefficient of roughness of pipe;

R = hydraulic radius =  $A/W_p$ , in feet;

$S_f$  = friction slope in pipe, in feet per foot; and

$W_p$  = wetted perimeter, in feet.

There are several general rules to be observed when designing storm sewer runs. When followed they will tend to alleviate or eliminate the common mistakes made in storm sewer design. These rules are as follows:

1. Select pipe size and slope so that the velocity of flow will increase progressively, or at least will not appreciably decrease, at inlets, bends, or other changes in geometry or configuration.
2. Do not discharge the contents of a larger pipe into a smaller one, even though the capacity of the smaller pipe may be greater due to steeper slope.
3. At changes in pipe size match the soffits of the two pipes at the same level rather than matching the flow lines. (When necessary for minimal fall, match the 0.8-diameter point of each pipe.)
4. Conduits are to be checked at the time of their design with reference to critical slope. If the slope of the line is greater than critical slope, the unit will likely be operating under entrance control instead of the originally assumed normal flow. Conduit slope should be kept below critical slope if at all possible. This also removes the possibility of a hydraulic jump within the line.

### Pipe Flow Charts

Figures 5-1 through 5-3 are nomographs for determining flow properties in circular pipe. The nomographs are based upon a value of "n" of 0.012 for concrete and 0.024 for corrugated metal. The charts are self-explanatory, and their use is demonstrated by the example in Figure 5-1.

For values of "n" other than 0.012, the value of Q should be modified by using the formula below:

$$Q_c = \frac{Q_n(0.012)}{n_c} \quad (5-3)$$

where:

$Q_c$  = flow based upon  $n_c$ ;

$n_c$  = value of "n" other than 0.012; and

$Q_n$  = flow from nomograph based on  $n = 0.012$ .

This formula is used in two ways. If  $n_c = 0.015$  and  $Q_c$  is unknown, use the known properties to find  $Q_n$  from the nomograph, and then use the formula to convert  $Q_n$  to the required  $Q_c$ . If  $Q_c$  is one of known properties, you must use the formula to convert  $Q_c$  (based on  $n_c$ ) to  $Q_n$  (based on  $n = 0.012$ ) first, and then use  $Q_n$  and the other known properties to find the unknown value on the nomograph.

#### Example 1

**Given:** Slope = 0.005; depth of flow,  $d = 1.8'$ ; diameter,  $D = 36''$ ;  $n = 0.018$ .

**Find:** Discharge,  $Q$ .

First determine  $d/D = 1.8'/3.0' = 0.6$ . Then enter Figure 5-1 to read  $Q_n = 34$  cfs. Using the formula,  $Q_c = 34 (0.12/0.018) = 22.7$  cfs (Answer).

#### Example 2

**Given:** Slope = 0.005; diameter  $D = 36''$ ;  $Q = 22.7$  cfs;  $n = 0.018$

**Find:** Velocity of flow (fps)

First convert  $Q_c$  to  $Q_n$ , so that the nomograph can be used. Using the formula  $Q_n = 22.7 (0.018/0.012) = 34$  cfs, enter Figure 5-1 to determine  $d/D = 0.6$ . Now enter Figure 5-3 to determine  $V = 7.5$  fps (Answer).

### 5.30 Hydraulic Gradient and Profile Of Storm Sewer

When storm sewer systems are designed for full flow the designer shall establish the head losses caused by flow resistance in the conduit, changes of momentum and interference at junctions and structures. This information shall then be used to establish the design water surface elevation at each structure.

Determination of the hydraulic grade line is not required for all storm drainage design. It is not necessary to compute the hydraulic grade line of a conduit run if the slope and the pipe sizes are chosen so that the slope is equal to or greater than friction slope, the inside top surfaces of successive pipes are lined up at changes in size, and the water surface at the point of discharge will not rise above the top of the outlet. In such cases the pipe will not operate under pressure and the slope of the water surface under capacity discharge will approximately parallel the slope of the invert of the pipe.

In the absence of these conditions or when it is desired to check the system against a larger flood than that used in sizing the pipes then the hydraulic and energy grade lines shall be computed and plotted. The friction head loss shall be determined by direct application of Manning's Equation or by appropriate nomographs in this Section. Minor losses due to turbulence at structures shall be determined by the procedure described below. The hydraulic grade line shall in no case be closer than two feet to the ground or street surface unless

otherwise approved by the appropriate agency. If the storm sewer system could be extended at some future date, present and future operation of the system must be considered.

### Total Energy Losses At Structures

The following total energy head losses at structures shall be determined for inlets, manholes, wye branches, or bends in the design of full flow closed conduits. Note total energy losses,  $h_j$  include minor losses,  $h_m$  and the change in velocity head,  $h_v$ . See Figures 5-4 and 5-6 for details of each case. Minimum head loss used at any structure shall be 0.10 feet, unless otherwise approved.

Short radius bends may be used on 24" and larger pipes when flow must undergo a direction change at a junction or bend. Reductions in head loss at manholes may be realized in this way. A manhole shall always be located at the end of such short radius bends.

### Minor Head Losses at Structures

The basic equations for minor head losses, where there is significant significant upstream and downstream velocity, takes the form as set forth below with the various conditions of the coefficient,  $k_m$ , shown in Tables 5-5, 5-6 and 5-7.

$$h_m = k_m \frac{V_2^2 - V_1^2}{2g} \quad (5-4)$$

where:

$h_m$  = junction or structure minor head loss, in feet;

$V_1$  = velocity in upstream pipe, in feet per second;

$V_2$  = velocity in downstream pipe, in feet per second;

$k_m$  = junction or structure coefficient of loss, in feet.

In the case where the initial velocity is negligible or when there is no velocity change the basic equation for head loss becomes:

$$h_m = k_m \frac{V_2^2}{2g} \quad (5-5)$$

Table 5-5

Junction or Structure

Minor Loss Coefficient  $k_m$

<u>Case No.</u>	<u>Reference Figure</u>	<u>Description of Condition</u>	<u>Coefficient <math>k_m</math></u>
VI	5-4b	Inlet or Manhole at Beginning of Line	1.25
VII	5-4b	Conduit on Curves for 90 degrees**	
		Curve radius = diameter	0.50
		Curve radius = 2 to 8 diameters	0.40
		Curve radius = 8 to 20 diameters	0.25
VIII	5-4b	Bends where Radius is Equal to Diameter	
		90-degree Bend	0.50
		60-degree Bend	0.43
		45-degree Bend	0.35
		22-1/2-degree Bend	0.20
		Manhole on Line with 60-degree Lateral	0.35
		Manhole on Line with 22-1/2-degree Lateral	0.75

\* Must be approved by appropriate agency

\*\* Where bends other than 90 degrees are used, the 90-degree bend coefficient can be used with the following percentage factor applied:

60-degree Bend--85%; 45-degree Bend--70%; 22-1/2-degree Bend--40%



## Obstructions

The values of the coefficient,  $k_j$ , for determining the loss of head due to obstructions in pipes are shown in Table 5-6, and the coefficients are used in the following equation to calculate the head loss at the obstruction:

$$h_m = k_m \frac{V_2^2}{2g} \quad (5-6)$$

Table 5-6

### Head Loss Coefficients Due to Obstructions

$\frac{A^*}{A.}$	$k_m$	$\frac{A^*}{A.}$	$k_m$
1.05	0.10	3.0	15.0
1.1	0.21	4.0	27.3
1.2	0.50	5.0	42.0
1.4	1.15	6.0	57.0
1.6	2.40	7.0	72.5
1.8	4.00	8.0	88.0
2.0	5.55	9.0	104.0
2.2	7.05	10.0	121.0
2.5	9.70		

\*  $A =$  Ratio of area of pipe to area of opening  
 $A.$  at obstruction

## Expansions and Contractions

The values of the coefficient,  $k_j$ , for determining the loss of head due to sudden enlargements and sudden contractions in pipes are shown in Table 5-7. These coefficients are used in the following equation to calculate the head loss at the change in section:

$$h_m = k_m \frac{V_2^2}{2g} \quad (5-7)$$

where:  $V_2$  = velocity in smaller pipe

Table 5-7

### Head Loss Coefficients for Expansions And Contractions

$\frac{D_2^*}{D_1}$	Sudden Enlargements	Sudden Contractions
	$k_m$	$k_m$
1.2	0.10	0.08
1.4	0.23	0.18
1.6	0.35	0.25
1.8	0.44	0.33
2.0	0.52	0.36
2.5	0.65	0.40
3.0	0.72	0.42
4.0	0.80	0.44
5.0	0.84	0.45
10.0	0.89	0.46
$\infty$	0.91	0.47

\*  $\frac{D_2}{D_1}$  = Ratio of larger to smaller diameter.

## 5.40 Design Procedure For Storm Sewer Systems

### Preliminary Design Procedure

- A. Prepare a drainage map of the entire area to be drained by proposed improvements. Contour maps serve as excellent drainage area maps when supplemented by field reconnaissance.
- B. Make a preliminary layout of the proposed storm drainage system, locating all inlets, manholes, mains, laterals, ditches, culverts, etc.
- C. Outline the drainage area for each inlet in accordance with present and future street development.
- D. Indicate on each drainage area a code identification number, the size of area, the direction of surface runoff by small arrows, and the coefficient of runoff for the area.
- E. Show all existing underground utilities.
- F. Establish design rainfall frequency.
- G. Establish inlet time of concentration.
- H. Establish the typical cross section of each street.
- I. Establish permissible spread of water on all streets within the drainage area.
- J. Include Steps A through I with plans submitted to the appropriate agency for review. The drainage map submitted shall be suitable for permanent filing with the appropriate agency and shall be a good-quality reproducible copy.

### Inlet System

Determining the size and location of inlets is largely a trial-and-error procedure. Using criteria outlined in Sections 2, 3, and 4 of this manual, the following steps will serve as a guide to the procedure to be used.

- A. Beginning at the upstream end of the project drainage basin, outline a trial subarea and calculate the runoff from it.
- B. Compare the calculated runoff to allowable street capacity. If the calculated runoff is greater than the allowable street capacity reduce the size of the trial subarea. If the calculated runoff is less than street capacity, increase the size of the trial subarea.

Repeat this procedure until the calculated runoff equals the allowable street capacity. This is the first point at which a portion of the flow must be removed from the street. The

percentage of flow to be removed will depend on street capacities versus runoff entering the street downstream.

- C. Record the drainage area, time of concentration, runoff coefficient and calculated runoff for the subarea. This information shall be recorded on the plans or in tabular form convenient for review.
- D. If an inlet is to be used to remove water from the street, size the inlet(s) and record the inlet size, amount of intercepted flow, and amount of flow carried over (bypassing the inlet).
- E. Continue the above procedure for other subareas until a complete system of inlets has been established. Remember to account for carry-over from one inlet to the next.
- F. After a complete system of inlets has been established, modification should be made to accommodate special situations such as point sources of large quantities of runoff, and variation of street alignments and grades.
- G. Record information as in Steps C and D for all inlets.
- H. After the inlets have been located and sized the inlet pipes can be designed.
- I. Inlet pipes are sized to carry the volume of water intercepted by the inlet. Inlet pipe capacities may be controlled by the gradient available, or by entry condition into the pipe at the inlet. Inlet pipe sizes should be determined for both conditions and the larger size thus determined used.

### **Storm Sewer System**

After the computation of the quantity of storm runoff entering each inlet, the storm sewer system required to carry the runoff is designed. It should be borne in mind that the quantity of flow to be carried by any particular section of the storm sewer system is not the sum of the inlet design quantities of all inlets above that section of the system, but is less than the straight total. This situation is due to the fact that as the time of concentration increases the rainfall intensity decreases.

#### **A. Storm Sewer Pipe**

The ground-line profile is now used in conjunction with the previous runoff calculations. The elevation of the hydraulic gradient is arbitrarily established approximately 2 feet below the ground surface. When this initial gradient is set and the design discharge is determined, a Manning's flow chart may be used to determine the pipe size and velocity.

It is probable that the initial gradient will have to be adjusted at this point since the intersection of the discharge and the slope on the chart will likely occur between standard pipe sizes. The smaller pipe should be used if the design discharge and corresponding slope does not result in an encroachment on the 2 foot criteria below the ground surface. If there is encroachment, use the larger pipe which will establish a capacity somewhat in excess of the design discharge. Velocities can be read directly from a Manning's Flow Chart based on a given discharge, pipe size, and slope.

**B. Junctions, Inlets and Manholes**

- A. Determine the hydraulic gradient elevations at the upstream end and downstream end of the pipe section in question. The elevation of the hydraulic gradient of the upstream end of pipe is equal to the elevation of the downstream end of pipe (hydraulic gradient) plus the product of the length of pipe and the pipe gradient.
- B. Determine the velocity of flow for incoming pipe (main line) at junction, inlet, or manhole at design point.
- C. Determine the velocity of flow for outgoing pipe (main line) at junction, inlet, or manhole at design point.
- D. Compute velocity head for outgoing velocity (main line) at junction, inlet, or manhole at design point.
- E. Compute velocity head for incoming velocity (main line) at junction, inlet, or manhole at design point.
- F. Determine head loss coefficient,  $k_j$ , at junction, inlet, or manhole at design point from Tables 5-5, 5-6, 5-7 or Figures 5-4a and 5-4b.
- G. Compute head loss at junction, inlet or manhole.  
$$h_j = k_j \frac{V_2^2 - V_1^2}{2g}$$
- H. Compute hydraulic gradient at upstream end of junction as if junction were not there.
- I. Add head loss to hydraulic gradient elevation determined to obtain hydraulic gradient elevation at upstream end of junction.

All information shall be recorded on the plans or in tabular form convenient for review.

### C. Major Storm System

Check the proposed system for the 100-year major storm event. Modify the proposed system or provide additional flow capacity as required to accommodate the major storm runoff according to the requirements stated in Sections 1, 3, 4, and 5.

#### 5.50 Bibliography

1. The American Society of Civil Engineers and the Water Pollution Control Federation, Design and Construction of Sanitary and Storm Sewers, A.S.C.E. Manual of Engineering Practice, No. 37 (W.P.C.F. Manual of Practice, No. 9) American Society of Civil Engineers, New York, New York, 1960.
2. City of Austin, Texas, Engineering Department, et al, Drainage Criteria Manual, Austin, Texas, 1977.
3. Albertson, Maurice L., Barton, James R., and Simons, Daryl B., Fluid Mechanics for Engineers. Prentice-Hall, Inc., Englewood Cliffs, New Jersey, 1960.
4. Chow, Ven Te, Open-Channel Hydraulics, McGraw-Hill Book Company, Inc., New York, New York, 1959.
5. Federal Aviation Administration, Airport Drainage, Government Printing Office, Washington, D.C., 1966.
6. National Clay Pipe Institute, Clay Pipe Engineering Manual, National Clay Pipe Institute, Crystal Lake, Illinois, 1968.
7. Portland Cement Association, Design and Construction of Concrete Sewers, Portland Cement Association, Skokie, Illinois, 1968.
8. Portland Cement Association, Handbook of Concrete Culvert Pipe Hydraulics, Portland Cement Association, Chicago, Illinois, 1964.
9. Sangster, W.M., Wood, H.W., Smendon, E.T., and Bossy, H.G., Pressure Changes of Storm Drain Junctions, Engineering Series Bulletin No. 41, University of Missouri, Columbia, Missouri, 1958.
10. Steel, Ernst, W., Water Supply and Sewerage, McGraw-Hill Book Co., Inc., New York, New York, 1960.
11. Wright-McLaughlin Engineers, Urban Storm Drainage Criteria Manual, Denver Regional Council of Governments, Colorado, 1969.

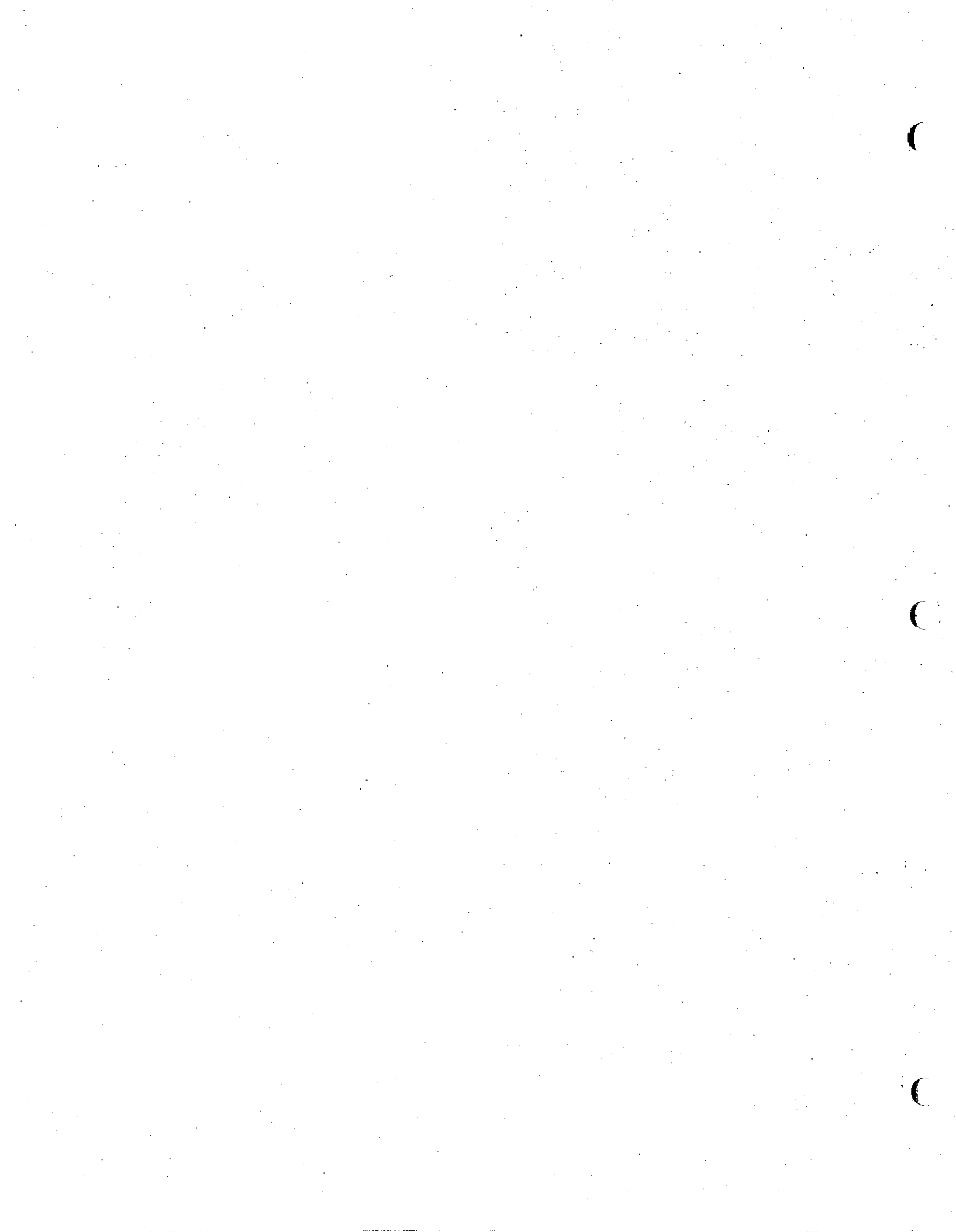

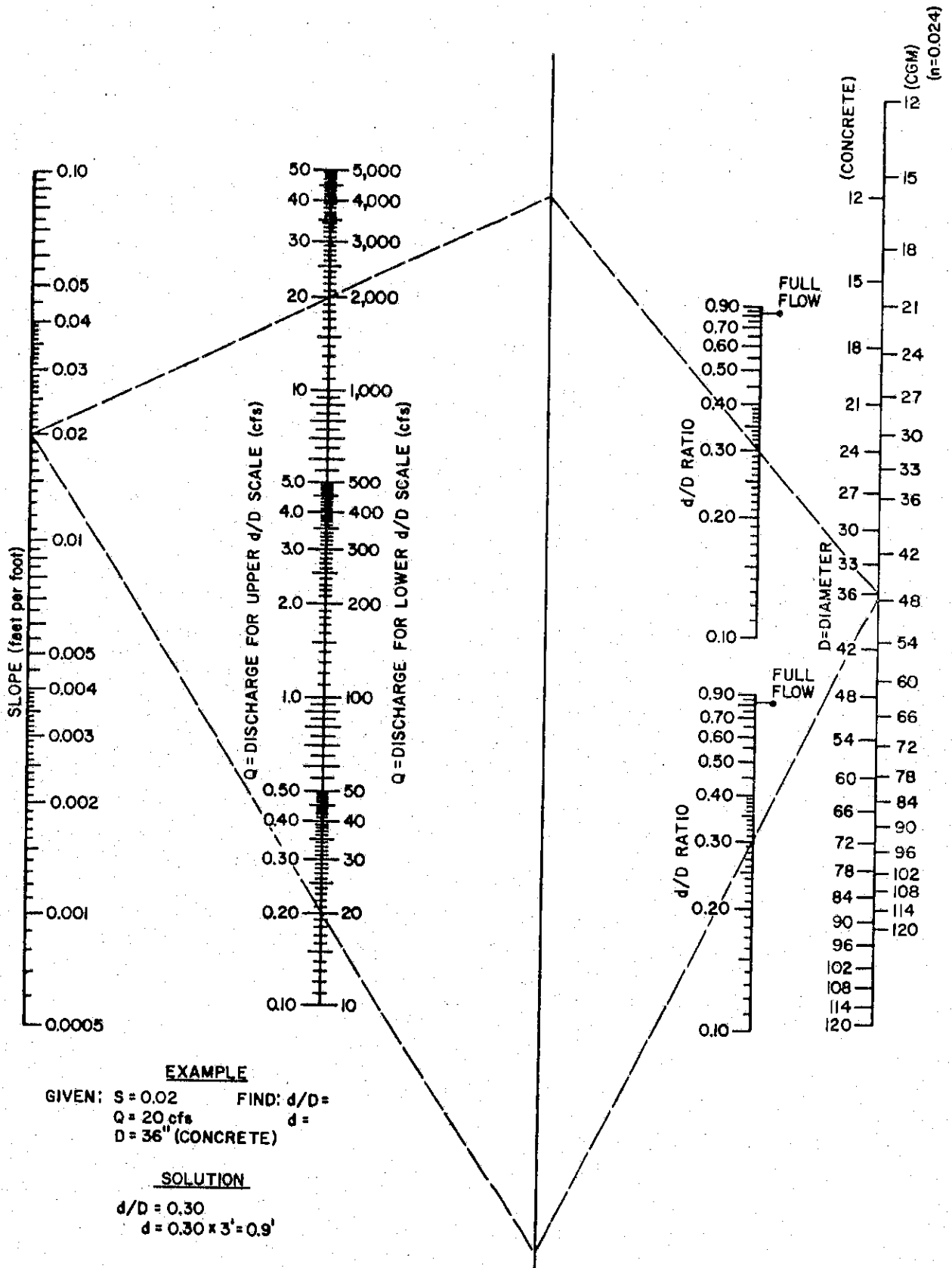

Figure 5-1 Uniform Flow for Pipe Culverts



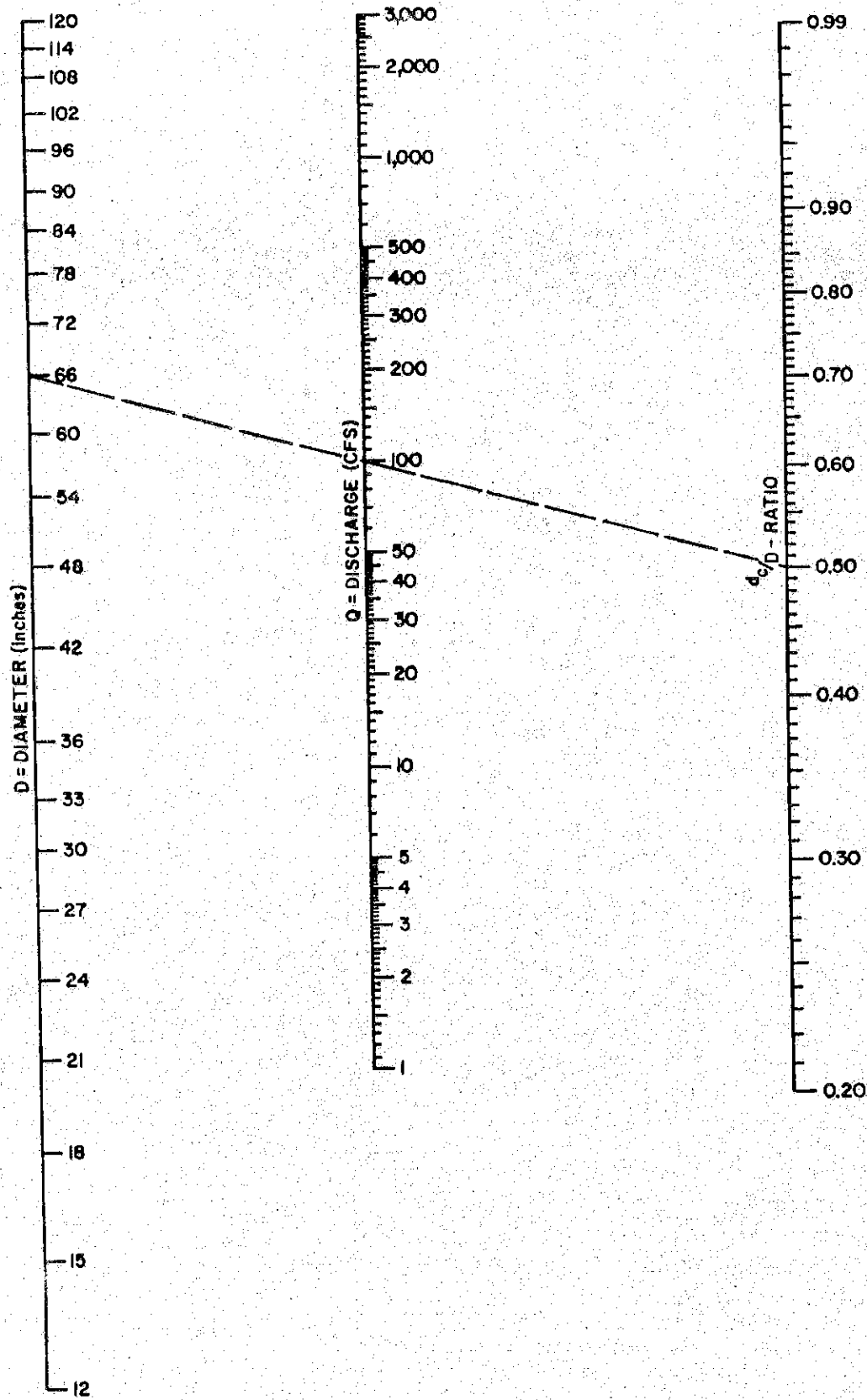

Figure 5-2 Critical Depth of Flow for Circular Conduits

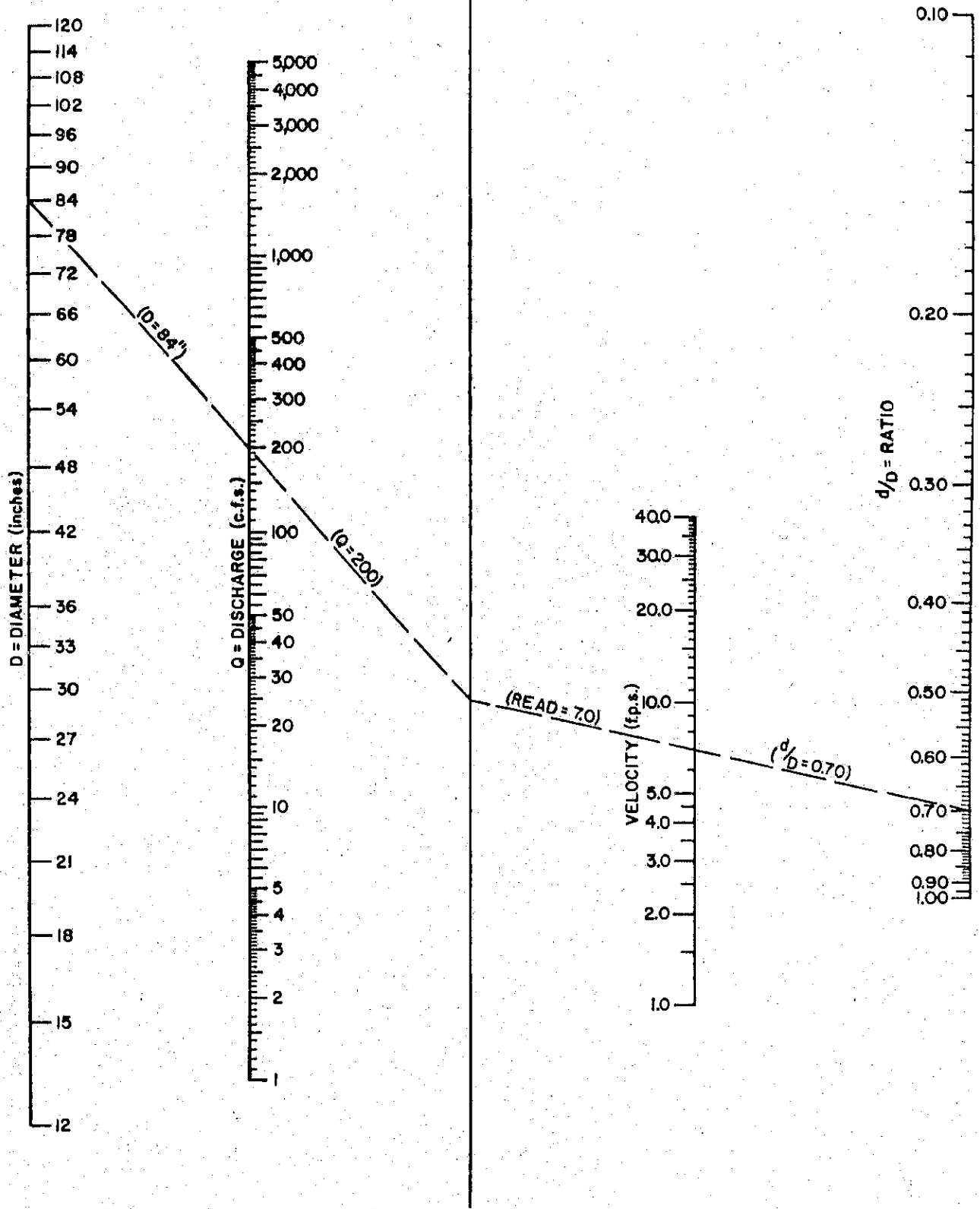

Figure 5-3 Velocity in Pipe Conduits



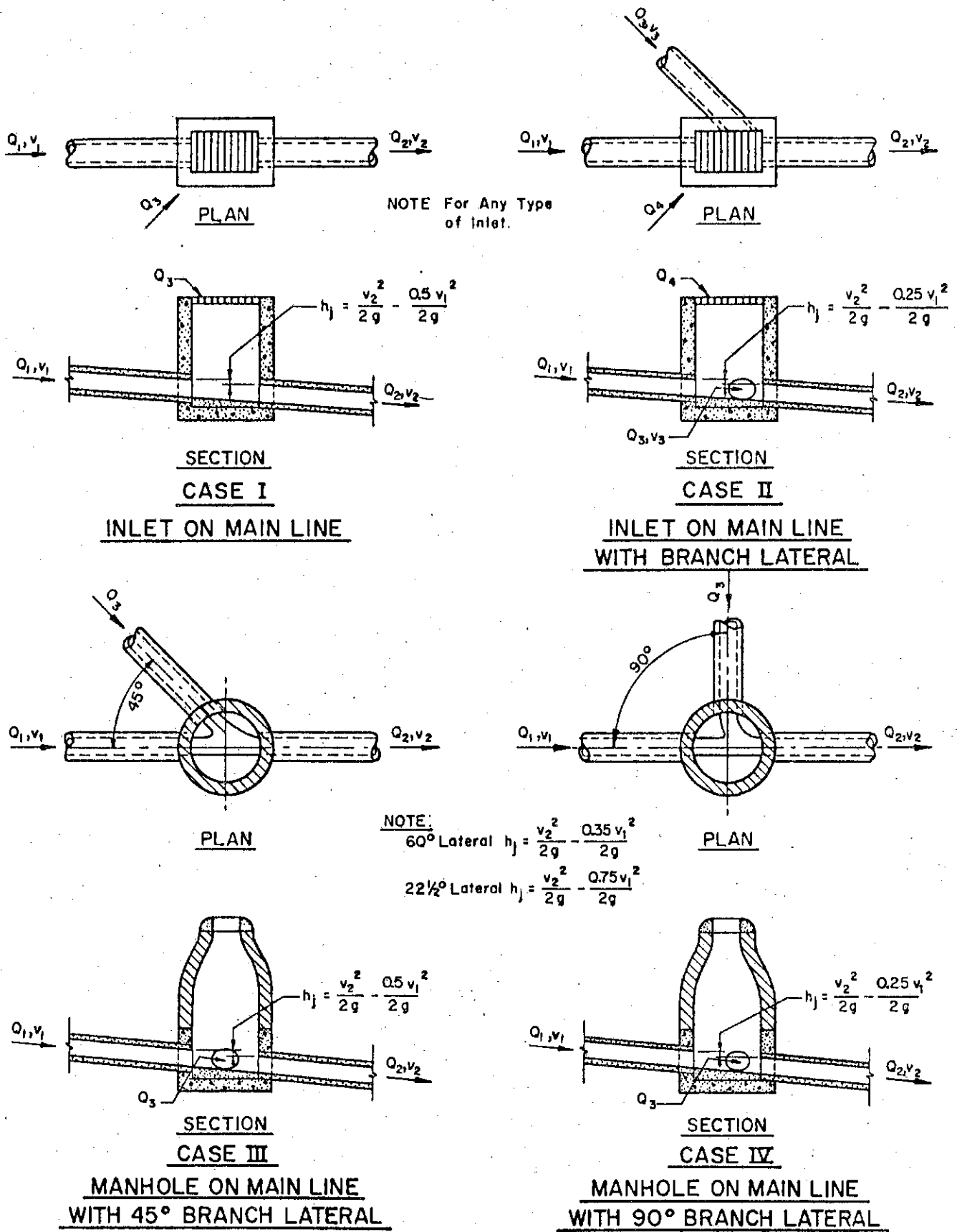
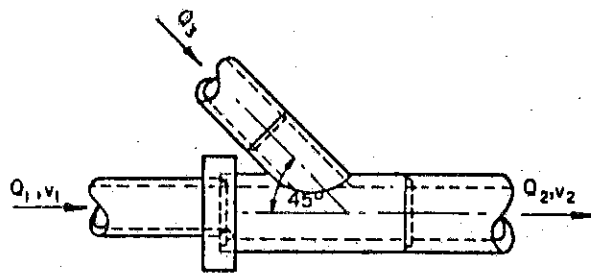
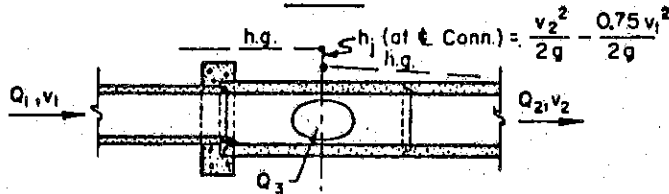

Figure 5-4 Minor Head Losses Due to Turbulence at Structures



PLAN



SECTION

CASE V

45° WYE CONNECTION  
OR CUT IN

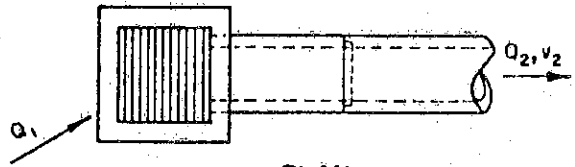

PLAN

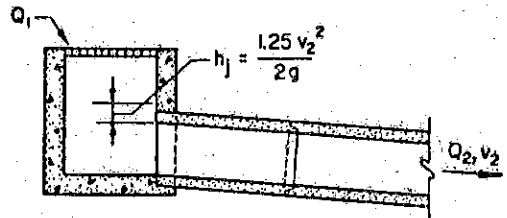

SECTION

CASE VI

INLET OR MANHOLE AT  
BEGINNING OF LINE

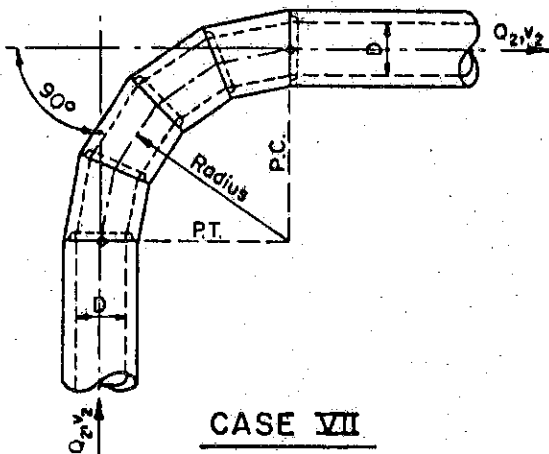

CASE VII

CONDUIT ON 90° CURVES\*

NOTE: Head loss applied at P.C. for length of curve.

Radius = Dia. of Pipe  $h_j = 0.50 \frac{v_2^2}{2g}$

Radius = (2-8) Dia. of Pipe  $h_j = 0.40 \frac{v_2^2}{2g}$

Radius = (8-20) Dia. of Pipe  $h_j = 0.25 \frac{v_2^2}{2g}$

Radius = Greater than 20 Dia. of Pipe  $h_j = 0$

\*When curves other than 90° are used, apply the following factors to 90° curves.

60° curve 85%

45° curve 70%

22 1/2° curve 40%

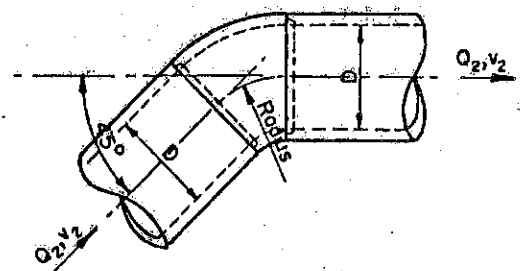

CASE VIII

BENDS WHERE RADIUS IS  
EQUAL TO DIAMETER OF PIPE

NOTE: Head loss applied at beginning of bend

90° Bend  $h_j = 0.50 \frac{v_2^2}{2g}$

60° Bend  $h_j = 0.43 \frac{v_2^2}{2g}$

45° Bend  $h_j = 0.35 \frac{v_2^2}{2g}$

22 1/2° Bend  $h_j = 0.20 \frac{v_2^2}{2g}$

Figure 5-4b Minor Head Losses Due To Turbulence at Structures